



TORIA

passionate by
nature

euro3plast
made in italy



Ihr Ansprechpartner in Österreich

T O R I A
KUNSTSTOFFHANDELS GMBH

Madstein 19 | 8772 Traboch | AUSTRIA
T +43 3847 8115 | F +43 3847 8115-30
verkauf@toria.at | www.toria.at



passionate by
nature

Immaginiamo soluzioni, abbiniamo colori, plasmiamo forme.
Ogni giorno cambiamo senza fermarci mai.
Ascoltiamo la ragione, ma è la passione che guida le nostre scelte
per superare la linea delle aspettative.
Ciascun prodotto è unico ed è il riflesso di ciò che siamo: persone che lavorano con
entusiasmo unendo organizzazione e intuizione.

Nous imaginons des solutions, nous associons des couleurs, nous modelons des
formes. Chaque jour nous changeons, sans jamais nous arrêter.
Nous écoutons la raison, mais c'est la passion qui dicte nos choix
pour franchir la ligne des attentes.
Chaque produit est unique et le reflet de ce que nous sommes: des personnes qui
travaillent avec enthousiasme, alliant organisation et intuition.

Wir erarbeiten Lösungen, stimmen Farben ab und gestalten Formen.
Jeden Tag erneuern wir uns ohne Pause.
Wir sind rational und doch werden unsere Entscheidungen durch unsere Leidenschaft
geprägt, die unsere Entscheidungen über alle Erwartungen hinaus beeinflusst.
Jedes Produkt ist einzigartig und spiegelt unseren Geist wider: wir arbeiten voller
Enthusiasmus und verbinden Organisation mit Eingebung.

Imaginamos soluciones, combinamos colores, plasmamos formas.
Cada día cambiamos sin detenernos nunca.
Escuchamos la razón, pero es la pasión que guía nuestras decisiones
para superar la línea de las expectativas.
Cada producto es único y es el reflejo de lo que somos: personas que trabajan con
entusiasmo uniendo organización e intuición.

We're always thinking up solutions, forms and matching colours.
Every day, we're changing, without ever stopping.
We listen to reason, but it is passion that guides our choices
to surpass expectations.
Every product is unique and reflects what we are: a team that works enthusiastically,
combining organization and intuition.



benvenuti tra le pagine del nostro catalogo

abbiamo pensato a spunti e suggestioni che ruotano attorno ad un mondo a noi tanto caro, quello dei giardini e delle ambientazioni da arredare con prodotti funzionali e decorativi.

Ci trovi anche on line su www.euro3plast.com

bienvenue dans notre catalogue

nous avons pensé à des idées et des conseils tournant autour d'un monde qui nous est cher, celui des jardins et des ambiances à meubler avec des produits fonctionnels et décoratifs.

Vous pouvez aussi nous trouver en ligne à l'adresse www.euro3plast.com

willkommen Sie auf den Seiten unseres Katalogs

wir haben uns Ideen und Vorschläge zur Welt der Gärten und Räumlichkeiten, die mit funktionalen und dekorativen Produkten ausgestattet werden sollen, ausgedacht.

Sie finden uns auch online unter www.euro3plast.com

bienvenidos entre las páginas de nuestro catálogo

hemos pensado a ideas y sugerencias que giran en torno a un mundo que adoramos, el de los jardines y ambientaciones para embellecer con productos funcionales y decorativos.

Estamos también en línea en las páginas www.euro3plast.com

welcome to our catalogue

we have thought up some ideas that focus on a world very dear to us: a world of gardens and settings to furnish with functional and decorative products.

Visit us at www.euro3plast.com

PASSIONATE BY NATURE



Get inspired by euro3plast!

company profile	6
tecnologie / technologies	14
certificazioni / certifications	18
servizi / services	19
sostenibilità / sustainability	22
hobby	26
home	70
style	110
avvertenze / warnings	208
indice generale / general index	214

PASSIONATE BY NATURE

A passion since 1974



it

Euro3plast nasce nel 1974 producendo prodotti in plastica per il giardino e per la casa. L'innovazione legata alla produzione di vasi, complementi d'arredo e lampade è alla base della continua crescita dell'azienda che oggi distribuisce i suoi prodotti in tutto il mondo.

fr

Euro3plast a été créé en 1974 et fabrique des produits en plastique pour le jardin et la maison. L'innovation caractérisant la production de pots, de compléments d'ameublement et de lampes est à la base de la croissance constante de l'entreprise qui distribue aujourd'hui ses produits dans le monde entier.

de

Euro3Plast entsteht im Jahr 1974 und fertigt Kunststoffartikel für Garten und Haushalt. Die Basis des kontinuierlichen Wachstums des Unternehmens, das seine Erzeugnisse heute weltweit vertreibt, ist die Innovation im Hinblick auf die Herstellung der Blumentöpfe, Einrichtungsobjekte und Leuchten.

es

Euro3plast fue fundada en 1974 para la fabricación de productos de plástico para el jardín y el hogar. La innovación vinculada a la producción de macetas, accesorios de decoración y dispositivos de iluminación es la base del continuo crecimiento de la empresa que hoy distribuye sus productos en todo el mundo.

en

Euro3plast was established in 1974 as a manufacturer of plastic products for home and garden. The innovation linked to the production of pots, furnishing accessories and lighting items, is at the base of the company's continuous growth, which distributes its products all over the world.

Our values are written in our DNA



Quality

it - Curiamo ogni minimo dettaglio

fr - Nous apportons le plus grand soin aux moindres détails

de - Wir achten auf das kleinste Detail

es - Cuidamos cada detalle

en - We care about every single detail

Reliability

it - Dedichiamo tempo e impegno per assicurare massimi livelli di servizio

fr - Nous consacrons beaucoup de temps et d'énergie afin de garantir un niveau de service aussi élevé que possible

de - Um ein Höchstmaß an Service gewährleisten zu können, wenden wir Zeit und Engagement auf

es - Dedicamos tiempo y compromiso para garantizar óptimos niveles de servicio

en - We devote time and commitment to ensuring the highest level of service

Innovation

it - La tecnologia come mezzo per esprimere al meglio la creatività

fr - La technologie pour exprimer au mieux la créativité

de - Die Technologie, die die Kreativität am besten zum Ausdruck bringt

es - La tecnología para expresar la creatividad de la mejor manera

en - Technology as a mean of expressing creativity in the best possible way

1974 

it - iniziamo a produrre i primi articoli per la casa

fr - lancement de la production de nos premiers articles pour la maison

de - wir produzieren unsere ersten Haushaltsartikel

es - empezamos a producir los primeros artículos para el hogar

en - we begin to manufacture the first items for the home

1983 

it - incrementiamo la produzione nel settore garden

fr - augmentation de la production dans le secteur garden

de - wir steigern die Produktion von Gartenartikeln

es - aumento de la producción en el sector jardín

en - we increase the production in the garden field

1992 

it - introduzione della produzione rotazionale

fr - introduction du rotomoulé

de - wir fangen mit dem Rotationsformen an

es - introducción del rotomoldeo

en - introduction of rotational moulding

2004 

it - trasferimento nel nuovo sito produttivo

fr - transfert à la nouvelle usine

de - wir ziehen in das neue Fabrikgebäude um

es - traslado a la nueva nave

en - moving to the new headquarters

2014 

it - i nostri primi 40 anni

fr - 40 ans de activité

de - unsere ersten 40 Jahren

es - los primeros 40 años

en - our first 40 years

2019 

it - nasce GREENER, linea di vasi in plastica riciclata

fr - naissance de GREENER, nos pots en plastique recyclé

de - Geburtsjahr von GREENER, die Blumentopfserie aus recyceltem Plastik

es - nace GREENER, línea de macetas en plástico reciclado

en - birth of GREENER, our line of pots made with recycled plastic

L'obiettivo 
è scegliere di essere originali, sempre!

Le but est choisir d'être toujours original!

Das Ziel ist immer originell zu sein!

El objetivo es elegir de ser original, siempre!

The goal is to choose to be original, always!

97%

it - livello di servizio garantito al cliente
fr - niveau de service garanti au client
de - garantiertes Kundenservice-Niveau
es - nivel de servicio garantizado al cliente
en - guaranteed customer service level

5%

it - percentuale investita nello sviluppo e ricerca di nuovi prodotti
fr - pourcentage investi dans le développement et la communication de nouveaux produits
de - investitionen in die Entwicklung und die Kommunikation für neue Erzeugnisse
es - porcentaje invertido en el desarrollo y la comunicación de nuevos productos
en - percentage invested in developing and communicating new products

warehouse

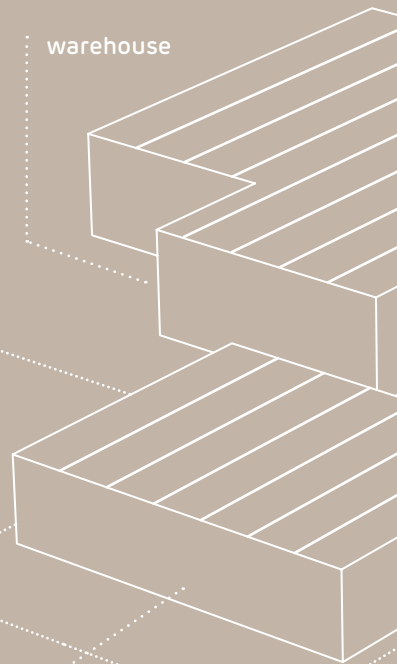

warehouse

3.600.000 kg

it - materia prima lavorata all'anno
fr - matière première travaillée par an
de - jährlich verarbeitete Rohstoffe
es - materia prima procesada por año
en - raw materials processed per year

120

it - tipologie di colori e finiture
fr - types de couleurs et de finitions
de - farben und oberflaechen-ausfuehrungen
es - distintos tipos de colores y acabados
en - types of colours and finishing

32.000 mq

it - superficie produttiva dell'azienda
fr - surface de production de l'entreprise
de - produktionsfläche
es - superficie de la empresa dedicada a la producción
en - manufacturing surface of the company

company profile
key facts



60

it - mercati differenti
fr - marchés différents
de - verschiedene Märkte
es - mercados diferentes
en - different markets

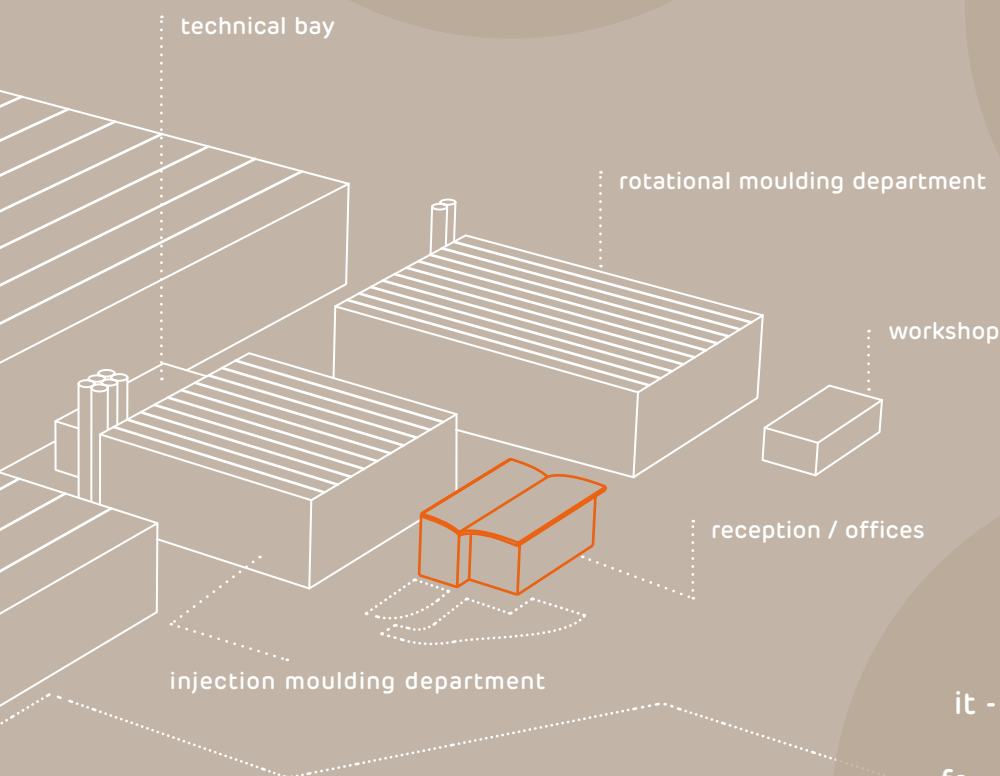

10
11

3

it - sistemi di gestione: qualità, ambiente e sicurezza
fr - systèmes de gestion: qualité, environnement et sécurité
de - managementsysteme: Qualität, Umwelt und Sicherheit
es - sistemas de gestión: calidad, medio ambiente y seguridad
en - management systems: quality, environment and safety

7.800.000

it - pezzi prodotti all'anno
fr - pièces produites par an
de - gefertigte Teile pro Jahr
es - piezas fabricadas por año
en - items produced per year

Our values



Quality

Cura e attenzione del dettaglio in ogni ambito.

Soin et attention au moindre détail, dans tous les domaines.

Sorgfältige Detailpflege in jedem Bereich.

Cuidado y atención del detalle en cada sector.

Care and attention to detail in every sphere.



Customer

"La nostra più grande risorsa è il cliente! Tratta ogni cliente come se fosse l'unico."

"Notre plus grande ressource, c'est le client ! Traitez chaque client comme si c'était le seul."

"Unser größtes Kapital ist der Kunde! Behandle jeden kunden so, als ob der einzige wäre."

"¡El cliente es nuestro mayor recurso! Trata cada cliente como si fuera el único."

"Our greatest asset are our customers! Treat every one of them as if they were the only one."
(Laurice Leitao)



Teamwork

Insieme diamo il nostro meglio!

Ensemble nous donnons le meilleur de nous-mêmes!

Gemeinsam geben wir unser Bestes!

Juntos damos lo mejor de nosotros mismos!

Together we express our best!

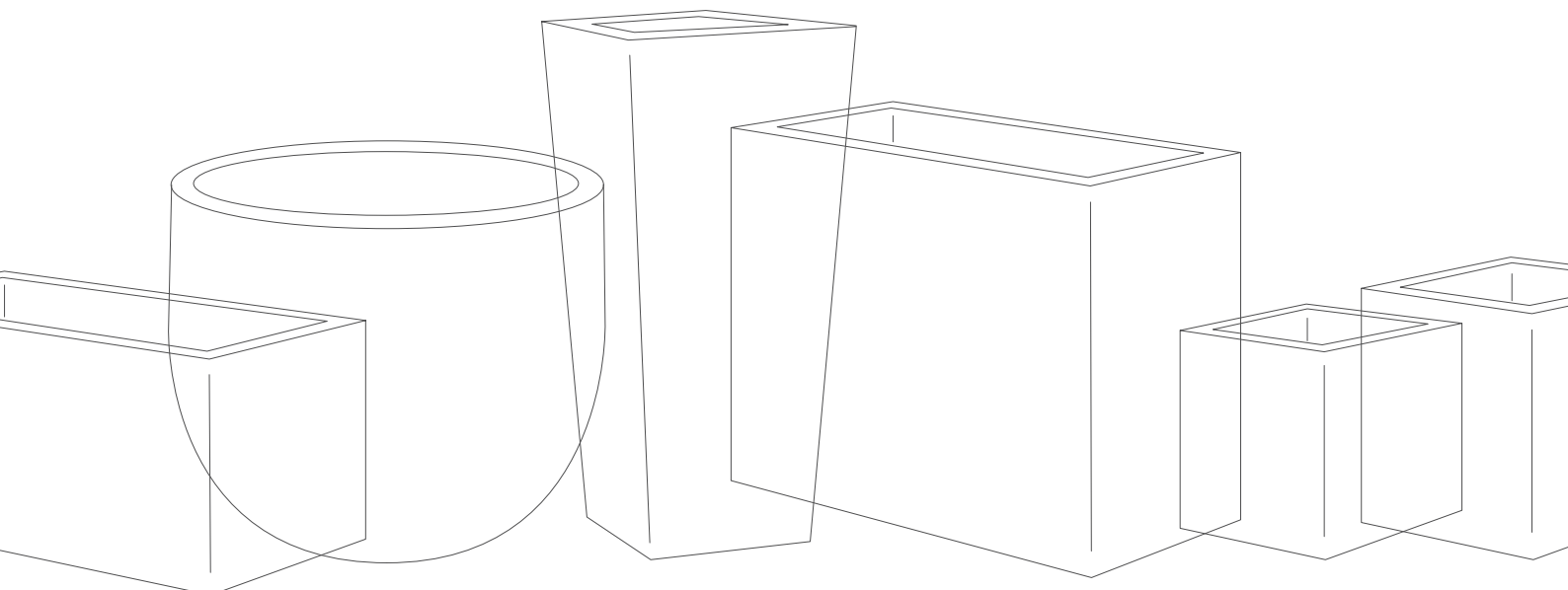



Passion

**"Scegli il lavoro che ami
e non lavorerai neppure
un giorno in tutta la tua vita"**

"Choisissez un travail que vous aimez et vous n'aurez pas à travailler un seul jour de votre vie"

"Wähle einen Beruf, den du liebst, und du brauchst keinen Tag in deinem Leben mehr zu arbeiten"

"Elige el trabajo que te guste y no tendrás que trabajar ni un solo día de tu vida"

"Choose a job you love and will never have to work a day in your life".
(Confucius)



Innovation

**Passione e curiosità
guidano l'innovazione:
un miglioramento continuo che
distingue il leader dal follower.**

Passion et curiosité guident l'innovation: une amélioration continue qui distingue le leader du suiveur.

Leidenschaft und Neugierde sind der Grundstein von Innovationen: die ständige Verbesserung unterscheidet den Marktführer vom Follower.

La pasión y la curiosidad guían la innovación: un mejoramiento continuo que distingue el líder del seguidor.

Passion and curiosity drive innovation: ongoing improvement that sets the leader apart from the followers.

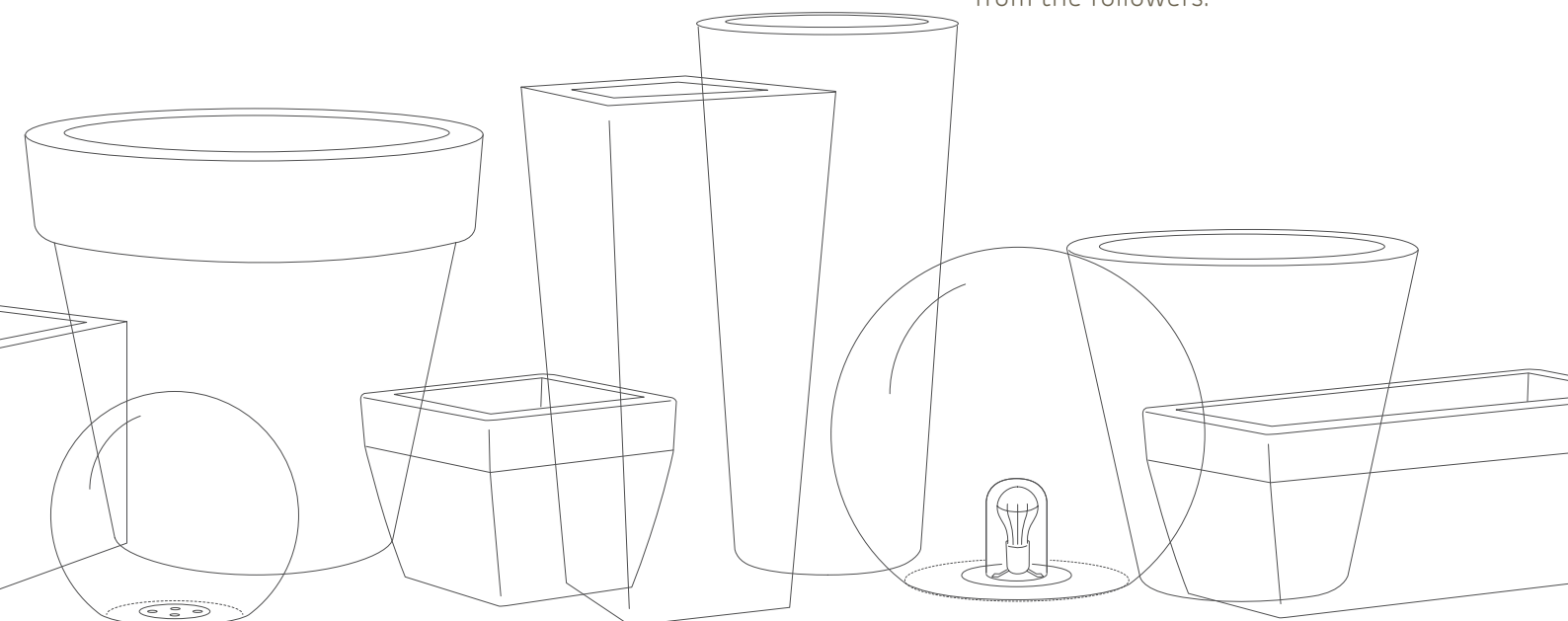

Injection moulding

it

Durante il ciclo di stampaggio a iniezione, il materiale scende dalla tramoggia, viene fuso e poi iniettato nell'impronta dello stampo grazie ad un pistone che scorre nella camera di fusione. Il prodotto viene estratto dopo una fase di raffreddamento che lo solidifica, plasmandolo secondo la forma dello stampo.

fr

Pendant le cycle de moulage, le matériau qui descend de la trémie est fondu, puis injecté dans l'empreinte du moule grâce à un piston qui se déplace dans la chambre de fusion. Le produit est extrait après une phase de refroidissement qui le solidifie et lui donne la forme du moule.

de

Während des Pressvorgangs läuft das Material aus dem Trichter, wird geschmolzen und dann mit Hilfe eines Kolbens, der sich in der Schmelzkammer bewegt, in die Form gespritzt. Im Anschluss an die Abkühlphase, in der das Teil in der Gestalt, die ihm die Form verleiht, erstarrt, wird der Artikel entnommen.

es

Durante el ciclo de moldeado, el material baja de la tolva, se funde y luego se inyecta en la forma del molde gracias a un pistón que se mueve en la cámara de fusión. El producto se extrae después de una fase de enfriamiento que lo solidifica, dándole forma según las líneas del molde.

en

During the moulding cycle, the material descends from the hopper, is made molten and then injected into the mould impression by a piston that slides into the melting chamber. The product is extracted after a cooling phase that solidifies it, shaping it to the mould.

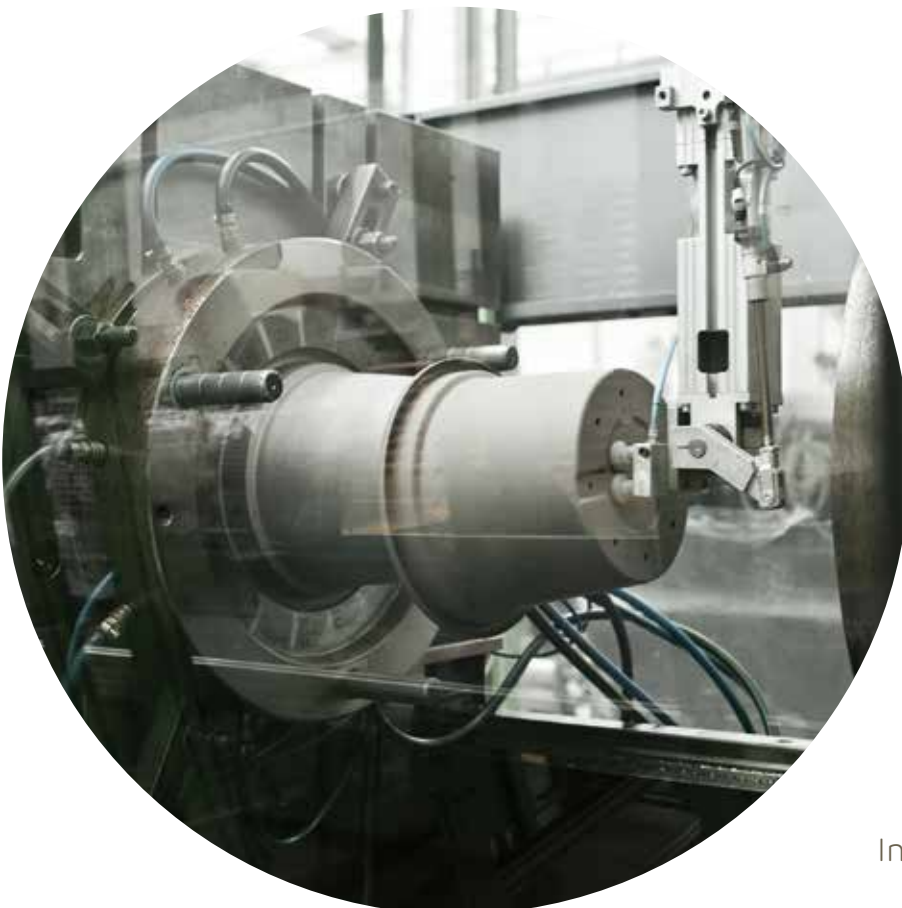

Injection moulding division







Rotational moulding

it

Le forme sono forgiate da stampi in alluminio dove il materiale in polvere viene inserito, poi riscaldato e fuso all'interno di un forno. Durante la fase di riscaldamento, il ciclo di stampaggio prevede una rotazione lenta, per distribuire il materiale sulle pareti in modo uniforme. Successivamente, il prodotto viene raffreddato, estratto dallo stampo e rifinito manualmente.

fr

Les formes sont créées à partir de moules en aluminium où le matériau en poudre est introduit, puis chauffé et fondu dans un four. Pendant la phase de chauffage, le cycle de moulage effectue une rotation lente pour distribuer uniformément le matériau sur les parois. Le produit est ensuite refroidi, extrait du moule et fini à la main.

de

Die Formen werden aus Aluminium geschmiedet und mit dem pulverförmigen Material gefüllt, das dann in einem Ofen erhitzt und geschmolzen wird. Während der Phase des Erhitzens sieht das Verfahren ein langsames Rotieren vor. Auf diese Weise wird das Material gleichmäßig an den Wänden verteilt. Anschließend wird das Teil abgekühlt, aus der Form entnommen und von Hand fein bearbeitet.

es

Las formas se forjan a partir de moldes de aluminio donde se introduce el material en polvo, se calienta y se funde en un horno. Durante la fase de calentamiento, el ciclo de moldeado implica una rotación lenta para distribuir el material uniformemente sobre las paredes. A continuación, el producto se enfría, se retira del molde y se termina manualmente.

en

The shapes are forged from aluminium moulds where the powder material is inserted, then heated and melted inside an oven. During the heating phase, the moulding cycle involves a slow rotation to distribute the material evenly on the walls. The product is then cooled, removed from the mould and hand-finished.



We certify our commitment

it - Abbiamo scelto di seguire normative severe, per garantire non solo la soddisfazione dei clienti, ma anche il rispetto dell'ambiente e la salvaguardia della salute.

fr - Nous avons choisi de suivre des normes sévères, afin de garantir non seulement la satisfaction des clients, mais aussi le respect de l'environnement et la protection de la santé.

de - Um nicht nur die Zufriedenheit unserer Kunden, sondern auch den Schutz der Umwelt und der Gesundheit zu gewährleisten, haben wir uns dafür entschieden, strenge Bestimmungen einzuhalten.

es - Hemos optado por la aplicación de normas estrictas para garantizar no solo la satisfacción de los clientes, sino también el respeto del medio ambiente y la protección de la salud.

en - We have chosen to follow strict regulations to ensure not only customer satisfaction, but also respect for the environment and the protection of health.



Quality management system
(UNI EN ISO 9001:2015)



Environment management system
(UNI EN ISO 14001:2015)



Safety management system
(ISO 45001:2018)

Noi per Voi progettiamo il punto vendita

Analizziamo e definiamo insieme l'ampiezza e le caratteristiche del vostro spazio espositivo, realizzando un progetto personalizzato e pensato su misura per voi.

Vous et nous nous concevons votre point de vente

Nous analysons et définissons ensemble la grandeur et les caractéristiques de votre espace d'exposition.
Nous réalisons un projet personnalisé et pensé sur mesure pour vous.

Wir Für Sie Wir gestalten Ihre Verkaufsstelle

Wir analysieren und definieren gemeinsam mit Ihnen die Größe und Eigenschaften Ihrer Ausstellungsfläche.
Wir verwirklichen ein auf Sie zugeschnittenes individuelles Projekt.





Nosotros para ustedes

diseñamos tu tienda

Analizamos y definimos conjuntamente la amplitud y las características de su espacio expositivo. Realizamos un proyecto personalizado y concebido a medida para ustedes.

Us for You

we design your store

Together, we analyse and define the size and characteristics of your display area. We create a personalized design to illustrate the installation we have conceived just for you.

THINK GREEN

Our ECO-FRIENDLY manifesto

it

Crediamo in un mondo sostenibile, trattiamo l'ambiente con il rispetto dovuto al nostro pianeta e alle future generazioni. Ci impegniamo ad attuare processi produttivi che minimizzino gli sprechi e favoriscano il riciclo. Stiamo attenti a rispettare la natura e sensibilizziamo il nostro personale a fare la raccolta differenziata e ad evitare l'acquisto di prodotti usa e getta.

fr

Nous croyons dans un monde durable, nous traitons l'environnement avec le respect dû à notre planète et aux futures générations. Nous nous engageons à mettre en œuvre des processus de production qui éliminent le gaspillage et favorisent le recyclage. Nous sommes attentifs au respect de l'environnement et sensibilisons notre personnel à faire le tri et à éviter tout achat de produits jetables.

de

Wir bekennen uns zu einer nachhaltigen Welt und behandeln die Umwelt mit der unserem Planeten und den zukünftigen Generationen gebührenden Achtung. Wir setzen uns für die Implementierung von Produktionsprozessen ein, durch die Abfälle minimiert und das Recycling gefördert werden. Wir bemühen uns um den Umweltschutz und halten unsere Mitarbeiter zur getrennten Sammlung und Vermeidung von Einwegprodukten an.



es

Creemos en un mundo sostenible, tratamos las cuestiones medioambientales con el respeto debido a nuestro planeta y a las generaciones futuras. Estamos comprometidos con los procesos de fabricación que minimizan los desperdicios y promueven el reciclaje. Respetamos el medio ambiente y sensibilizamos a nuestro personal para dedicarse a la recogida selectiva de residuos y evitar la compra de productos desechables.

en

We believe in a sustainable world, and treat the environment with the respect we owe to our planet and future generations. We're committed to implementing manufacturing processes that minimize waste and promote recycling. And we take care over respecting nature and enhancing awareness among our staff about recycling, and avoiding buying disposable products.

PASSIONATE BY NATURE



Impianti con sistema
di gestione ambientale

Installations avec système
de gestion environnementale

Anlagen mit
Umweltmanagementsystem

Instalaciones con sistema
de gestión medioambiental

Plant and equipment with
environmental management system

OUR GREEN SOUL...



Materie prime e masterbatch
privi di metalli pesanti

Matières premières et mélanges-
maîtres sans métaux lourds

Rohstoffe und Masterbatches
ohne Schwermetalle

Materias primas y concentrados
de color sin metales pesados

Raw materials and masterbatches
free of heavy metals



Prodotti riciclabili al 100%

Produits recyclables à 100 %

100 % recycelbare Erzeugnisse

Productos reciclables al 100%

100% recyclable products



Imballi riciclabili

Emballages recyclables

Recycelbare Verpackungen

Embalajes reciclables

Recyclable packaging



ISO 14001:2015

La nostra garanzia nei confronti dell'ambiente

ISO 14001:2015

Notre garantie pour l'environnement

ISO 14001:2015

Unsere Gewähr der Umwelt gegenüber

ISO 14001:2015

Nuestra garantía para con el medio ambiente

ISO 14001:2015

Our guarantee for the environment

...IS OUR COMMITMENT FOR A BETTER PLANET

24
25



Sfridi rigenerati in materia prima

Déchets régénérés en matière première

Wiederaufbereitete Anfälle im Rohmaterial

Recortes regenerados de materia prima

Waste regenerated into raw material



hobby



100%
Recyclable



Lightweight



Antishock



U.V.
Resistant







Temperature
Resistant





geo | vaso • pot

art.	size				medea	
1983	Ø 13 (cm 13 x 10 h)	L 0,8	80	1471 • Ø 12	03 G9 62 01	
1972	Ø 15 (cm 15 x 11 h)	L 1,2	80	1472 • Ø 14	03 G9 62 01	
1973	Ø 18 (cm 18 x 14 h)	L 2,0	40	1474 • Ø 18	03 G9 62 01	
1974	Ø 20 (cm 20 x 15 h)	L 2,9	40	1475 • Ø 20	03 M9 G9 62 L4 T4 T6 01 T5	
1975	Ø 25 (cm 25 x 19 h)	L 5,6	10	1477 • Ø 24	03 M9 G9 62 L4 T4 T6 01 T5	
1976	Ø 30 (cm 30 x 23 h)	L 9,7	10	1479 • Ø 28	03 M9 G9 62 L4 T4 T6 01 T5	
1977	Ø 35 (cm 35 x 26 h)	L 15,4	10	1481 • Ø 32	03 M9 G9 62 L4 T4 T6 01 T5	

geo

good for plants



pp



vaso con fori
pot with holes



sottovaso abbinato
fitting saucer



display solutions



espositore
display



palbox



3057 total expe
(cm 63 x 123 x 210 h)







28
29

art.	size				medea	
1978	Ø 40	(cm 40 x 30 h)	L 23,2	10	1483 • Ø 40	03 M9 G9 62 L4 T4 T6 01 T5
1979	Ø 45	(cm 45 x 34 h)	L 33,0	10	1484 • Ø 44	03 M9 G9 62 L4 01
1980	Ø 50	(cm 50 x 38 h)	L 45,3	10	1485 • Ø 48	03 M9 G9 62 L4 01
2058	Ø 55	(cm 55 x 41 h)	L 60,4	10	1486 • Ø 52	03 G9 62 01
1981	Ø 60	(cm 60 x 45 h)	L 78,4	5	1487 • Ø 56	03 G9 62 01
1982	Ø 70	(cm 70 x 53 h)	L 124,6	5	1488 • Ø 64	03 G9 62 01

stabile e
capiente
stable and
capacious



cilindro | vaso • pot

art.	size				medea 	
1192	Ø 10	(cm 10 x 7 h)	L 0,3	180	1469 • Ø 8	01
1244	Ø 13	(cm 13 x 9 h)	L 0,7	80	1471 • Ø 12	01
1193	Ø 15	(cm 15 x 11 h)	L 1,0	80	1472 • Ø 14	01
1245	Ø 18	(cm 18 x 13 h)	L 1,8	40	1474 • Ø 18	01
1175	Ø 20	(cm 20 x 14 h)	L 2,5	40	1475 • Ø 20	01
1174	Ø 25	(cm 25 x 18 h)	L 5,0	10	1477 • Ø 24	01
1124	Ø 30	(cm 30 x 21 h)	L 9,0	10	1479 • Ø 28	01

cilindro

good for plants



pp



vaso con fori
pot with holes



sottovaso abbinato
fitting saucer



display solutions



espositore
display



palbox



30
31











art.	size				medea	
1112	Ø 35	(cm 35 x 25 h)	L 14	10	1481 • Ø 32	01
1113	Ø 40	(cm 40 x 28 h)	L 21	10	1483 • Ø 40	01
1114	Ø 45	(cm 45 x 31 h)	L 25	10	1484 • Ø 44	01
1125	Ø 50	(cm 50 x 35 h)	L 41	10	1485 • Ø 48	01
1176	Ø 60	(cm 60 x 42 h)	L 70	5	1487 • Ø 56	01
1300	Ø 90	(cm 90 x 62 h)	L 250	2	1960 • Ø 82	01

robusto e
capiente

sturdy and
capacious



coccio | vaso • pot

art.	size				medea 	
1062	Ø 16 (cm 16 x 14 h)	L 1	80	1472 • Ø 14		
1063	Ø 18 (cm 18 x 16 h)	L 2	80	1473 • Ø 16		
1064	Ø 20 (cm 20 x 17 h)	L 3	80	1474 • Ø 18		
1065	Ø 22 (cm 22 x 19 h)	L 4	80	1475 • Ø 20		
1246	Ø 24 (cm 24 x 21 h)	L 6	10	1476 • Ø 22		
1247	Ø 27 (cm 27 x 23 h)	L 8	10	1478 • Ø 26		
1248	Ø 30 (cm 30 x 25 h)	L 11	10	1479 • Ø 28		



coccio

good for plants



pp



vaso con fori
pot with holes



sottovaso abbinato
fitting saucer







display solutions



espositore
display





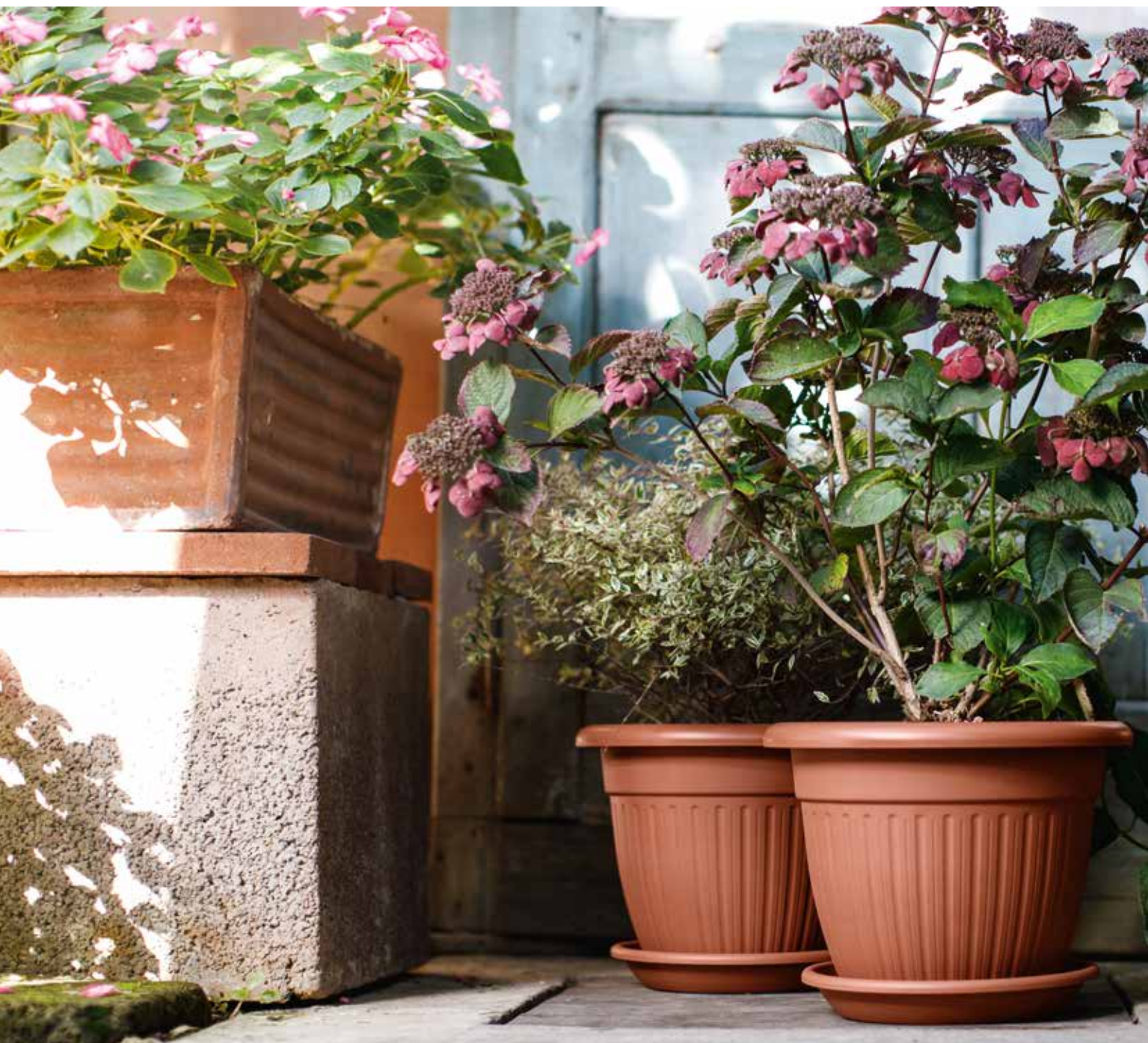

3057 total expe
(cm 63 x 123 x 210 h)

art.	size				medea 	
1249	Ø 35 (cm 35 x 27 h)		L 18	10	1481 • Ø 32	01
1316	Ø 40 (cm 40 x 31 h)		L 25	10	1482 • Ø 36	01
1317	Ø 45 (cm 45 x 35 h)		L 34	10	1483 • Ø 40	01



dune | vaso • pot

art.	size				medea 	
1280	Ø 20	(cm 20 x 16 h)	L 2,5	40	1473 • Ø 16	01
1281	Ø 25	(cm 25 x 19 h)	L 5,0	10	1475 • Ø 20	01
1282	Ø 30	(cm 29 x 23 h)	L 8,0	10	1477 • Ø 24	01
1283	Ø 35	(cm 34 x 27 h)	L 13,0	10	1479 • Ø 28	01



dune

good for plants



pp



vaso con fori
pot with holes



sottovaso abbinato
fitting saucer





easy for sales



impilabile
stackable





34
35

art.	size				medea	
1284	Ø 40	(cm 39 x 31 h)	L 19,0	10	1481 • Ø 32	01
1285	Ø 45	(cm 44 x 35 h)	L 29,0	10	1482 • Ø 36	01
1286	Ø 50	(cm 49 x 39 h)	L 39,0	10	1483 • Ø 40	01

robusto
sturdy



linto | vaso • pot

art.	size				medea 	
1664	Ø 18	(cm 18 x 14 h)	L 1,6	40	1472 • Ø 14	01
1665	Ø 20	(cm 20 x 16 h)	L 2,5	40	1473 • Ø 16	01
1666	Ø 25	(cm 25 x 20 h)	L 4,8	10	1475 • Ø 20	01
1667	Ø 30	(cm 30 x 23 h)	L 8,3	10	1477 • Ø 24	01
1668	Ø 35	(cm 35 x 27 h)	L 13,5	10	1479 • Ø 28	01

linteo

good for plants



pp



vaso con fori
pot with holes



sottovaso abbinato
fitting saucer

easy for sales











impilabile
stackable



art.	size				medea	
1669	Ø 40	(cm 40 x 31 h)	L 19	10	1481 • Ø 32	01
1670	Ø 45	(cm 45 x 35 h)	L 29	10	1482 • Ø 36	01
1671	Ø 50	(cm 50 x 39 h)	L 39	10	1483 • Ø 40	01



garden | vaso • pot

art.	size				moplen	
349	Ø 12 (cm 12 x 10 h)	L 0,6	80	1037 • Ø 10		
350	Ø 14 (cm 14 x 12 h)	L 0,9	80	1/12 • Ø 12		
351	Ø 16 (cm 16 x 14 h)	L 1,5	80	1/14 • Ø 14		
352	Ø 18 (cm 18 x 16 h)	L 2,3	80	1/16 • Ø 16		
353	Ø 20 (cm 20 x 18 h)	L 3,3	10	1/18 • Ø 18		

garden

good for plants



pp



vaso con fori
pot with holes



sottovaso abbinato
fitting saucer







easy for sales





impilabile
stackable



art.	size				moplen	
354	Ø 22	(cm 22 x 19 h)	L 4,4	10	1/18 • Ø 18	02
355	Ø 24	(cm 24 x 21 h)	L 5,5	10	1/22 • Ø 22	02
356	Ø 27	(cm 27 x 22 h)	L 8,0	10	1/24 • Ø 24	02
357	Ø 30	(cm 30 x 23 h)	L 11,0	10	1/26 • Ø 26	02
918	Ø 35	(cm 35 x 26 h)	L 17,0	10	1/30 • Ø 30	02



akea | cassetta • plant box

art.	size				
1680	cm 50	(cm 50 x 28 x 22 h)	L 16	6	03 69 62 01
1681	cm 60	(cm 60 x 31 x 26 h)	L 26	6	03 69 62 01
1683	cm 80	(cm 80 x 39 x 34 h)	L 60	4	03 69 62 01
1684	cm 100	(cm 100 x 46 x 40 h)	L 100	2	03 69 62 01



akea

good for plants



pp



cassetta con fori
plant box with holes



sottocassetta abbinata
fitting oblong tray

easy for sales



vaso abbinato
matching pot



display solutions



cover pallet

40
41



akea | sottocassetta • oblong tray

art.	size			
1685	cm 50	(cm 46 x 22 x 3,0 h)	6	03 69 62 01
1686	cm 60	(cm 55 x 26 x 3,7 h)	6	03 69 62 01
1687	cm 80	(cm 73 x 32 x 4,7 h)	4	03 69 62 01
1689	cm 100	(cm 90 x 36 x 5,7 h)	2	03 69 62 01

molto capiente
very capacious



krea | vaso quadro • square pot

art.	size				
1702	cm 25	(cm 25 x 25 x 22 h)	L 6,5	10	69 62 01
1703	cm 30	(cm 31 x 31 x 26 h)	L 12,0	10	69 62 01
1704	cm 35	(cm 35 x 35 x 30 h)	L 17,0	10	69 62 01
1705	cm 40	(cm 39 x 39 x 34 h)	L 24,0	10	03 69 62 01
1706	cm 45	(cm 46 x 46 x 40 h)	L 38,0	5	03 69 62 01

krea

good for plants



pp



vaso con fori
pot with holes



sottovaso abbinato
fitting saucer

easy for sales



cassetta vaso abbinati
matching plant box pot

display solutions



cover pallet



42
43

krea | sottovaso quadro • square saucer

art.	size			
1707	cm 25	(cm 22 x 22 x 3,0 h)	10	G9 62 01
1708	cm 30	(cm 26 x 26 x 3,7 h)	10	G9 62 01
1709	cm 35	(cm 29 x 29 x 4,2 h)	10	G9 62 01
1710	cm 40	(cm 32 x 32 x 4,7 h)	10	03 G9 62 01
1711	cm 45	(cm 36 x 36 x 5,7 h)	5	03 G9 62 01

molto capiente
very capacious



krea | vaso angolo • angle pot

art.	size				
1743	cm 45	(cm 46 x 46 x 40 h)	L 35	5	01

krea | sottovaso angolo • angle saucer

art.	size			
1745	cm 45	(cm 39 x 39 x 5,7 h)	5	01

krea

good for plants



pp



vaso con fori
pot with holes



sottovaso abbinato
fitting saucer

easy for sales



cassetta vaso abbinati
matching plant box pot



44
45

krea | vaso a muro • wall pot

art.	size				
1742	cm 45 (cm 46 x 38 x 40 h)		L 27	5	01

krea | sottovaso a muro • wall saucer

art.	size			
1744	cm 45 (cm 36 x 30 x 5,7 h)		5	01



inis | cassetta • plant box

art.	size				
1987	cm 40	(cm 40 x 19,5 x 16,4 h)	L 8	12	03 M9 G9 62 T4 T6 01 T5
1988	cm 50	(cm 50 x 19,5 x 16,4 h)	L 10	12	03 M9 G9 62 T4 T6 01 T5
1989	cm 60	(cm 60 x 19,5 x 16,4 h)	L 12	12	03 M9 G9 62 T4 T6 01 T5
2055	cm 80	(cm 80 x 19,5 x 16,4 h)	L 17	6	03 M9 G9 62 01



inis

good for plants



pp



cassetta con fori
plant box with holes



sottocassetta abbinata
fitting oblong tray





display solutions



palbox





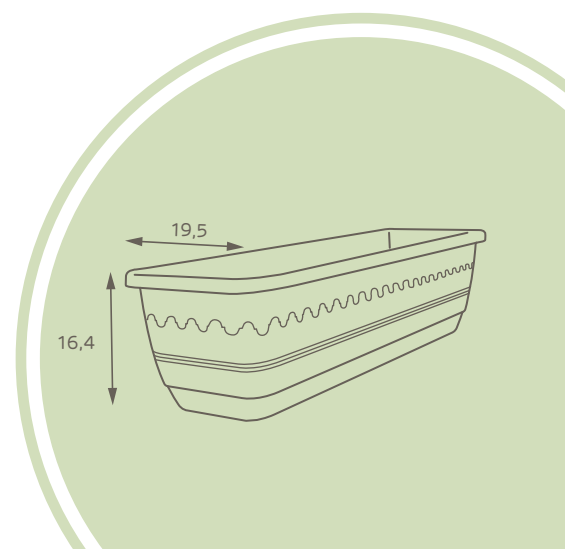

inis | sottocassetta • oblong tray

art.	size			
1990	cm 40	(cm 36,6 x 16,1 x 3 h)	12	03 M9 G9 62 T4 T6 01 T5
1991	cm 50	(cm 46,6 x 16,1 x 3 h)	12	03 M9 G9 62 T4 T6 01 T5
1992	cm 60	(cm 56,6 x 16,1 x 3 h)	12	03 M9 G9 62 T4 T6 01 T5
2056	cm 80	(cm 76,6 x 16,1 x 3 h)	6	03 M9 G9 62 01





gardenie | cassetta • plant box

art.	size				
2327	cm 40	(cm 40 x 20 x 16 h)	L 8	24	
2328	cm 50	(cm 50 x 20 x 16 h)	L 10	24	
2329	cm 60	(cm 60 x 20 x 16 h)	L 12	24	



gardenie

good for plants



pp



cassetta con fori
plant box with holes



sottocassetta abbinata
fitting oblong tray





easy for sales





impilabile
stackable

gardenie | sottocassetta • oblong tray



art.	size			
2330	cm 40	(cm 37 x 17 x 2,7 h)	24	G9 62 02 01
2331	cm 50	(cm 47 x 17 x 2,7 h)	24	G9 62 02 01
2332	cm 60	(cm 57 x 17 x 2,7 h)	24	G9 62 02 01



gerani | cassetta • plant box



art.	size				
1017	cm 30	(cm 30 x 17 x 14 h)	L 5	25	02 01
1018	cm 35	(cm 35 x 17 x 14 h)	L 6	25	02 01
1019	cm 40	(cm 40 x 17 x 14 h)	L 7	25	03 02 01
1020	cm 50	(cm 50 x 17 x 14 h)	L 9	25	03 02 01
1021	cm 60	(cm 60 x 17 x 14 h)	L 11	25	03 02 01

gerani | sottocassetta • oblong tray

art.	size			
1067	cm 30	(cm 26 x 13 x 3 h)	25	02 01
1068	cm 35	(cm 31 x 13 x 3 h)	25	02 01
1069	cm 40	(cm 36 x 13 x 3 h)	25	03 02 01
1070	cm 50	(cm 46 x 13 x 3 h)	25	03 02 01
1071	cm 60	(cm 56 x 13 x 3 h)	25	03 02 01





garden | sottocassetta • oblong tray

art.	size			
360	cm 30	(cm 29 x 16 x 2 h)	50	02 01
361	cm 35	(cm 34 x 16 x 2 h)	50	02 01
362	cm 40	(cm 39 x 16 x 2 h)	50	03 02 01
363	cm 50	(cm 49 x 16 x 2 h)	50	03 02 01
364	cm 60	(cm 59 x 16 x 2 h)	50	03 02 01



domus | gerla con sottovaso •
wall pot with saucer











art.	size				
1800	cm 25	(cm 25 x 16 x 18 h)	L 2,9	24	01
1801	cm 30	(cm 30 x 19 x 21 h)	L 5,1	24	01

pedino | pedino • little base

art.			
1462	(cm 7,7 x 4,1 x 4,9 h)	40	62 01 45



kalis | cassetta • plant box

art.	size				
1941	cm 50	(cm 50 x 25 x 21 h)	L 16	12	 
1888	cm 60	(cm 60 x 25 x 21 h)	L 20	12	 
1889	cm 80	(cm 80 x 25 x 21 h)	L 28	6	 
1890	cm 100	(cm 100 x 25 x 21 h)	L 35	6	 



kalis

good for plants



pp



cassetta con fori
plant box with holes



sottocassetta abbinata
fitting oblong tray









easy for sales



impilabile
stackable

52
53

kalis | sottocassetta • oblong tray

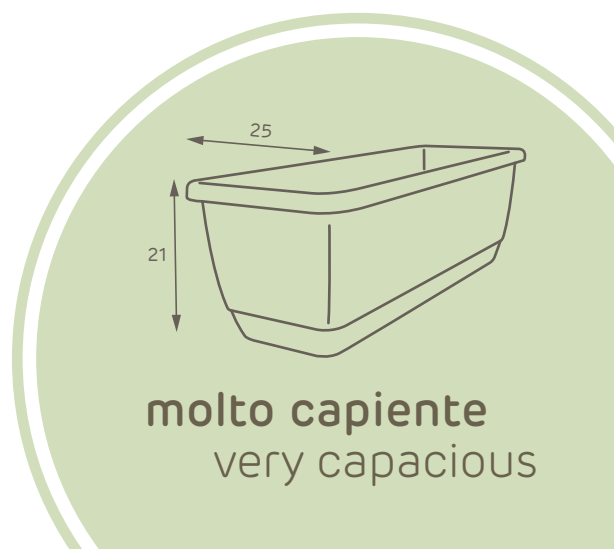

art.	size			
1942	cm 50	(cm 45,6 x 20,6 x 3,5 h)	12	
1891	cm 60	(cm 55,6 x 20,6 x 3,5 h)	12	
1892	cm 80	(cm 75,6 x 20,6 x 3,5 h)	6	
1893	cm 100	(cm 95,6 x 20,6 x 3,5 h)	6	



molto capiente
very capacious



licum | cassetta con sottocassetta montata • plant box with attached oblong tray

art.	size				
1999	cm 20	(cm 20 x 12,5 x 10,8 h)	L 1,5	12	03 02 01
2000	cm 30	(cm 30 x 12,5 x 10,8 h)	L 2,5	12	03 02 01
2001	cm 40	(cm 40 x 12,5 x 10,8 h)	L 3,0	12	03 02 01



licum

good for plants



pp



sottocassetta montata
attached oblong tray

display solutions





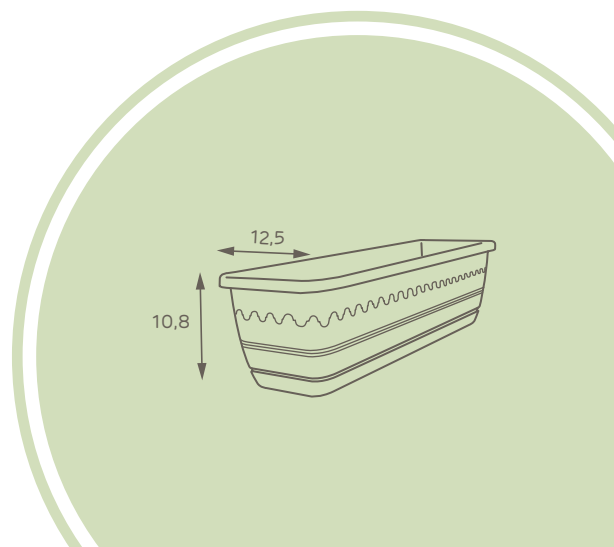



palbox





miza | cassetta • plant box

art.	size				
1897	cm 40	(cm 40 x 21,7 x 18 h)	L 10	12	
1898	cm 50	(cm 50 x 21,7 x 18 h)	L 13	12	
1899	cm 60	(cm 60 x 21,7 x 18 h)	L 16	12	



miza

good for plants



pp



cassetta con fori
plant box with holes



sottocassetta abbinata
fitting oblong tray

easy for sales



impilabile
stackable

56
57

miza | sottocassetta • oblong tray



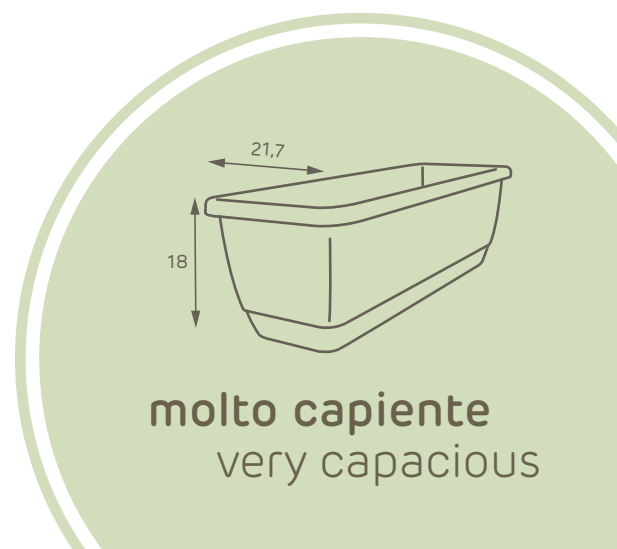





art.	size			
1900	cm 40	(cm 36 x 17,9 x 3 h)	12	G9 62 01
1901	cm 50	(cm 46 x 17,9 x 3 h)	12	G9 62 01
1902	cm 60	(cm 56 x 17,9 x 3 h)	12	G9 62 01



molto capiente
very capacious



olimpo | ciotola • plant bowl

art.	size				medea 	
1375	Ø 20	(cm 20 x 8 h)	L 1,4	20	1474 • Ø 18	
1376	Ø 25	(cm 25 x 9 h)	L 2,7	20	1476 • Ø 22	
1359	Ø 30	(cm 30 x 11 h)	L 4,7	20	1478 • Ø 26	
1454	Ø 35	(cm 35 x 13 h)	L 7,5	20	1481 • Ø 32	
1360	Ø 40	(cm 40 x 15 h)	L 11,0	20	1482 • Ø 36	



olimpo

good for plants



pp



vaso con fori
pot with holes





















sottovaso abbinato
fitting saucer



easy for sales









impilabile
stackable

art.	size				medea	
1500	Ø 45 (cm 45 x 17 h)	L 16	10	1483 • Ø 40	  	
1361	Ø 50 (cm 50 x 19 h)	L 22	10	1484 • Ø 44	  	
1362	Ø 60 (cm 60 x 23 h)	L 38	10	1485 • Ø 48	  	
1363	Ø 70 (cm 70 x 27 h)	L 60	5	1487 • Ø 56	  	
1455	Ø 90 (cm 90 x 34 h)	L 128	2	1960 • Ø 82	 	



libis | ciotola con sottovaso montato • plant bowl with attached saucer

art.	size				
2427	Ø 25	(cm 25 x 11 h)	L 3,6	12	
2428	Ø 30	(cm 30 x 13 h)	L 6,4	12	
2429	Ø 35	(cm 35 x 15 h)	L 10,0	12	



libis

good for plants



pp



sottovaso montato
attached saucer



display solutions



palbox



medea | sottovaso • saucer

art.	size		cilindro 	coccio 	dune 	geo 	linteo 	olimpo 		
1469	Ø 8	(cm 9,6 x 1,6 h)	1192						200	01
1470	Ø 10	(cm 11,0 x 1,8 h)					1662		200	01
1471	Ø 12	(cm 12,8 x 2,1 h)	1244			1983	1663		200	03 G9 62 01
1472	Ø 14	(cm 14,3 x 2,4 h)	1193	1062	1279	1972	1664		200	03 G9 62 01
1473	Ø 16	(cm 15,9 x 2,6 h)		1063	1280		1665		100	01
1474	Ø 18	(cm 17,9 x 2,9 h)	1245	1064		1973		1375	100	03 G9 62 01
1475	Ø 20	(cm 20,0 x 3,3 h)	1175	1065	1281	1974	1666		100	03 M9 G9 62 L4 T4 T6 01 T5
1476	Ø 22	(cm 22,0 x 3,6 h)		1246				1376	100	G9 62 01
1477	Ø 24	(cm 23,9 x 3,7 h)	1174		1282	1975	1667		100	03 M9 G9 62 L4 T4 T6 01 T5
1478	Ø 26	(cm 26,0 x 3,9 h)		1247				1359	100	G9 62 01
1479	Ø 28	(cm 27,9 x 4,2 h)	1124	1248	1283	1976	1668		50	03 M9 G9 62 L4 T4 T6 01 T5



medea

good for plants



pp



display solutions



espositore
display









2652 iko sottovasi • saucers
(cm 100 x 100 x 192 h)

art.	size		cilindro	coccio	dune	geo	linto	olimpo			
1480	Ø 30	(cm 30 x 4,4 h)								50	G9 01
1481	Ø 32	(cm 32 x 4,6 h)	1112	1249	1284	1977	1669	1454	50	03 M9 G9 62 L4 T4 T6 01 T5	
1482	Ø 36	(cm 36 x 5,0 h)		1316	1285		1670	1360	50	G9 62 01	
1483	Ø 40	(cm 40 x 5,4 h)	1113	1317	1286	1978	1671	1500	50	03 M9 G9 62 L4 T4 T6 01 T5	
1484	Ø 44	(cm 44 x 5,8 h)	1114			1979		1361	24	03 M9 G9 62 L4 01	
1485	Ø 48	(cm 48 x 6,2 h)	1125	1318	1287	1980	1672	1362	25	03 M9 G9 62 L4 01	
1486	Ø 52	(cm 52 x 6,7 h)				2058			24	03 G9 62 01	
1487	Ø 56	(cm 56 x 6,9 h)	1176	1394	1288	1981	2028	1363	25	03 G9 62 01	
1488	Ø 64	(cm 64 x 7,0 h)	1194	1427		1982	2029		15	03 G9 62 01	
1960	Ø 82	(cm 82 x 8,7 h)	1300					1455	5	01	



sottovaso con ruote | sottovaso con ruote montate • saucer with attached wheels

art.	size		 cilindro	 cocchio	 dune	 geo	 linteo		
1954	Ø 21	(cm 21,1 x 9,2 h)	1174	1246	1282	1975	1667	6	01
1107	Ø 25	(cm 24,8 x 10,8 h)	1124	1247	1283	1976	1668	6	01
1108	Ø 28	(cm 27,8 x 11,0h)		1248	1284		1669	6	01
1109	Ø 31	(cm 30,3 x 11,1 h)	1112	1249	1285	1977	1670	6	01
1110	Ø 35	(cm 35,4 x 11,4 h)	1113	1316	1286	1978	1671	6	01
1955	Ø 39	(cm 39,0 x 12,0 h)	1114	1317		1979		6	01
1111	Ø 42	(cm 42,0 x 12,0 h)	1125	1318	1287	1980	1672	6	01
1661	Ø 48	(cm 48,4 x 12,2 h)	1176	1394	1288	2058	2028	6	01
1956	Ø 56	(cm 56,0 x 13,1 h)	1194	1427		1982	2029	6	01

sottovaso con ruote

good for plants



pp



easy for sales



impilabile
stackable





64
65

portata
elevata
high load
capacity





sabbiato | sottovaso • saucer

art.	size			
1313	Ø 6	(cm 6,0 x 1,3 h)	200	01
1314	Ø 8	(cm 8,0 x 1,5 h)	200	01
1229	Ø 10	(cm 9,0 x 1,4 h)	200	01
3/12	Ø 12	(cm 12,0 x 2,4 h)	200	01
3/14	Ø 14	(cm 14,0 x 2,7 h)	200	01
3/16	Ø 16	(cm 16,2 x 2,9 h)	100	01
3/18	Ø 18	(cm 18,0 x 3,2 h)	100	01
3/20	Ø 20	(cm 20,0 x 3,4 h)	100	01
3/22	Ø 22	(cm 22,0 x 3,7 h)	100	01
3/24	Ø 24	(cm 24,0 x 4,0 h)	100	01
3/26	Ø 26	(cm 26,0 x 4,2 h)	100	01
3/28	Ø 28	(cm 28,0 x 4,4 h)	50	01
3/30	Ø 30	(cm 30,0 x 4,7 h)	50	01
3/35	Ø 35	(cm 35,0 x 5,0 h)	50	01
3/40	Ø 40	(cm 40,0 x 5,3 h)	50	01
3/45	Ø 45	(cm 45,0 x 5,5 h)	50	01
3/50	Ø 50	(cm 50,0 x 5,2 h)	25	01
3/55	Ø 55	(cm 58,6 x 5,8 h)	25	01
3/60	Ø 60	(cm 63,6 x 6,0 h)	25	01





moplen | sottovaso • saucer

art.	size			
1037	Ø 10	(cm 10,0 x 2,3 h)	200	02
1/12	Ø 12	(cm 11,9 x 2,5 h)	200	02
1/14	Ø 14	(cm 13,9 x 2,9 h)	200	02
1/16	Ø 16	(cm 15,7 x 3,1 h)	100	02
1/18	Ø 18	(cm 17,9 x 3,3 h)	100	02
1/20	Ø 20	(cm 19,8 x 3,5 h)	100	02
1/22	Ø 22	(cm 21,9 x 3,6 h)	100	02
1/24	Ø 24	(cm 23,9 x 3,9 h)	100	02
1/26	Ø 26	(cm 25,9 x 4,2 h)	100	02
1/28	Ø 28	(cm 27,9 x 4,5 h)	50	02
1/30	Ø 30	(cm 29,8 x 4,7 h)	50	02
1/35	Ø 35	(cm 34,9 x 5,0 h)	50	02
1/40	Ø 40	(cm 39,9 x 5,2 h)	50	02
1/45	Ø 45	(cm 45,0 x 5,5 h)	50	02
1/50	Ø 50	(cm 49,8 x 5,6 h)	25	02





air | sottovaso trasparente •
transparent saucer



art.	size			
2619	Ø 10	(cm 10,0 x 2,3 h)	200	(E1)
2620	Ø 12	(cm 11,9 x 2,5 h)	200	(E1)
2621	Ø 14	(cm 13,9 x 2,9 h)	200	(E1)
2622	Ø 16	(cm 15,7 x 3,1 h)	100	(E1)
2623	Ø 18	(cm 17,9 x 3,3 h)	100	(E1)
2624	Ø 20	(cm 19,8 x 3,5 h)	100	(E1)
2625	Ø 22	(cm 21,9 x 3,6 h)	50	(E1)
2626	Ø 24	(cm 23,9 x 3,9 h)	50	(E1)
2627	Ø 26	(cm 25,9 x 4,2 h)	50	(E1)
2628	Ø 28	(cm 27,9 x 4,5 h)	50	(E1)
2629	Ø 30	(cm 29,8 x 4,7 h)	50	(E1)
2630	Ø 35	(cm 34,9 x 5,0 h)	50	(E1)
2631	Ø 40	(cm 39,9 x 5,2 h)	50	(E1)
2632	Ø 45	(cm 45,0 x 5,5 h)	50	(E1)
2633	Ø 50	(cm 49,8 x 5,6 h)	25	(E1)



mini | sottocassetta • oblong tray

art.	size			
1238	cm 30	(cm 30 x 16 x 4 h)	25	01
1239	cm 35	(cm 35 x 17 x 5 h)	25	01
1240	cm 40	(cm 41 x 18 x 5 h)	25	01
1241	cm 46	(cm 47 x 20 x 5 h)	25	01
1242	cm 52	(cm 53 x 22 x 6 h)	25	01
1243	cm 62	(cm 63 x 23 x 7 h)	25	01

moplen | sottocassetta • oblong tray

art.	size			
2/25	cm 25	(cm 25 x 15 x 4,0 h)	25	02
2/30	cm 30	(cm 30 x 16 x 4,0 h)	25	02
2/35	cm 35	(cm 35 x 17 x 5,0 h)	25	02
2/40	cm 40	(cm 40 x 18 x 5,0 h)	25	02
2/46	cm 46	(cm 46 x 20 x 5,0 h)	25	02
2/52	cm 52	(cm 52 x 22 x 5,9 h)	25	02
2/62	cm 62	(cm 63 x 20 x 5,8 h)	25	02

home



100%
Recyclable



Lightweight



Antishock



U.V.
Resistant



Temperature
Resistant







tuit | vaso con container • pot with container

art.	size						
2785	Ø 33 (cm 33 x 61 h)	L 38,0	L 16	A4374	4		
2858	Ø 40 (cm 40 x 75 h)	L 69,5	L 29	A4430	2		

tuit

good for plants



pp



kit riserva d'acqua
water reserve kit

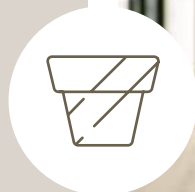

display solutions



cover pallet



72
73

Eleganti e funzionali sono adatti per arredare sia ambienti indoor che outdoor e per essere utilizzati sia come vasi che come coprivasi.

Both elegant and functional, they are ideal to furnish both indoor and outdoor settings, and to be used both as pots and as cachepots.

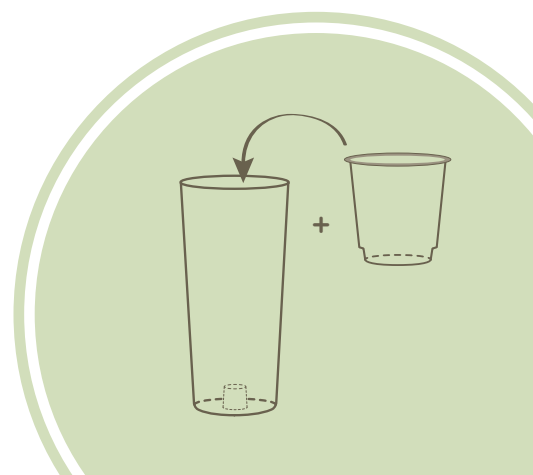

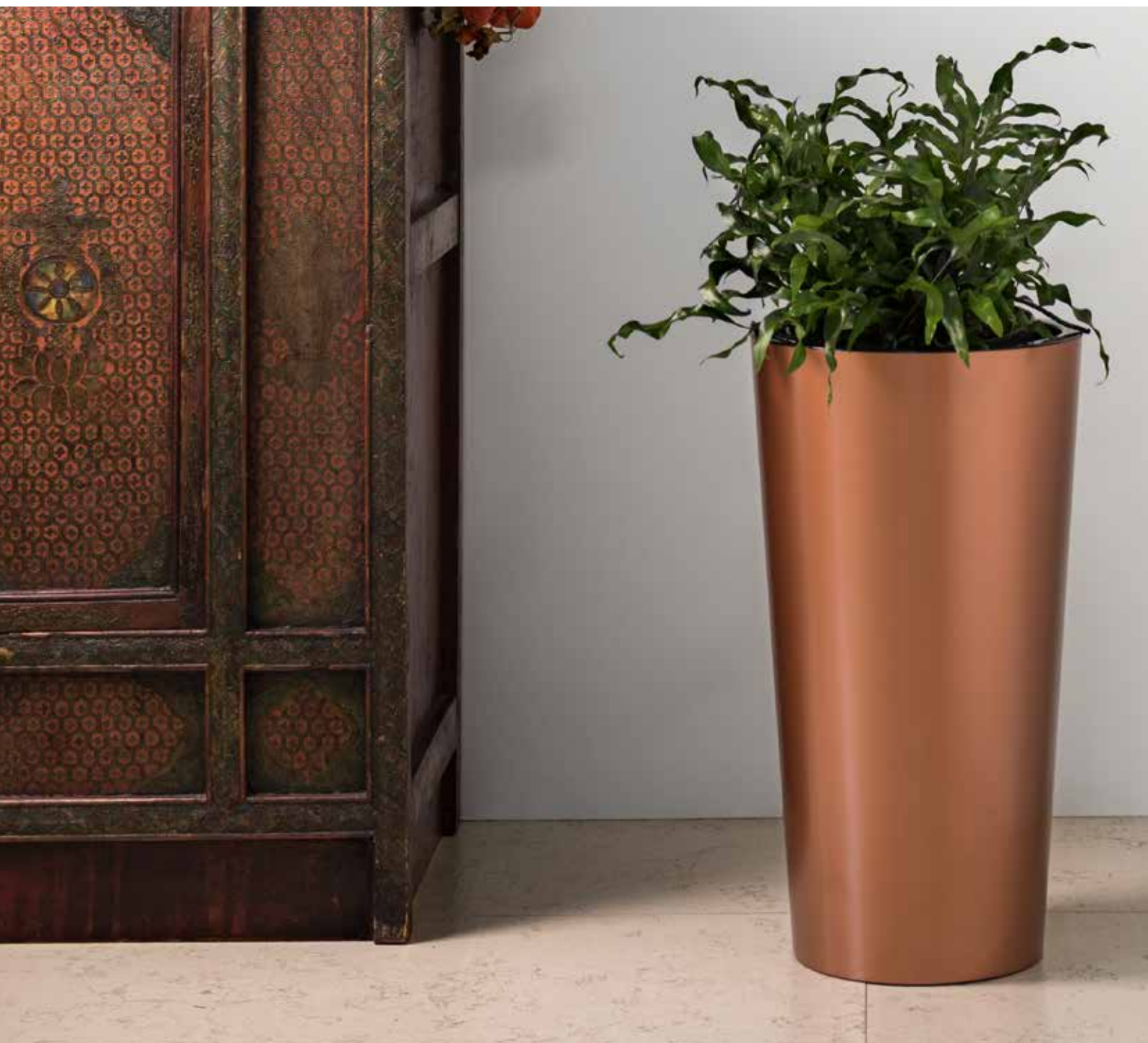

tuit laccato opaco | vaso laccato opaco con container • matt lacquered pot with container

art.	size						
3047	Ø 33	(cm 33 x 61 h)	L 38	L 16	A4374	4	



tuit

laccato opaco • matt lacquered

good for **plants**



pp



kit riserva d'acqua
water reserve kit

display solutions



cover pallet

Sottoposti a un accurato processo di laccatura, si vestono di una esclusiva finitura opaca.

Having received an elaborate lacquering process, they have a precious matt finish

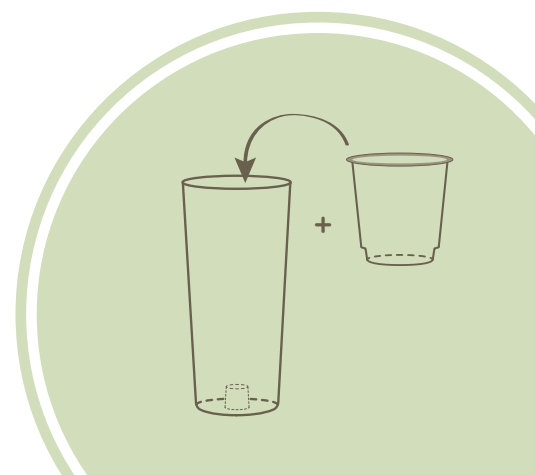



tuit krome | vaso con container • pot with container

art.	size						
3046	Ø 33	(cm 33 x 61 h)	L 38	L 16	A4374	4	  



tuit

krome

good for **plants**



pp



kit riserva d'acqua
water reserve kit

display solutions



cover pallet

Sottoposti a un particolare processo di metallizzazione sottovuoto dell'alluminio, si vestono di un sottile strato di metallo che li trasforma in eleganti sculture riflettenti.

By undergoing a special process of aluminium vacuum metalization, they are dressed in a thin layer of metal that transforms them into elegant reflective sculptures.

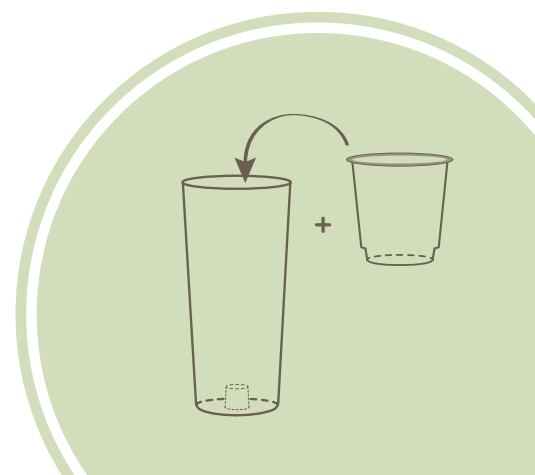



up | vaso • pot

art.	size				
2988	Ø 25	(cm 25 x 20 x 23 h)	L 4	6	



up

good for plants



pp

display solutions



espositore
display



palbox



3064 global expe
(cm 56 x 56 x 183 h)

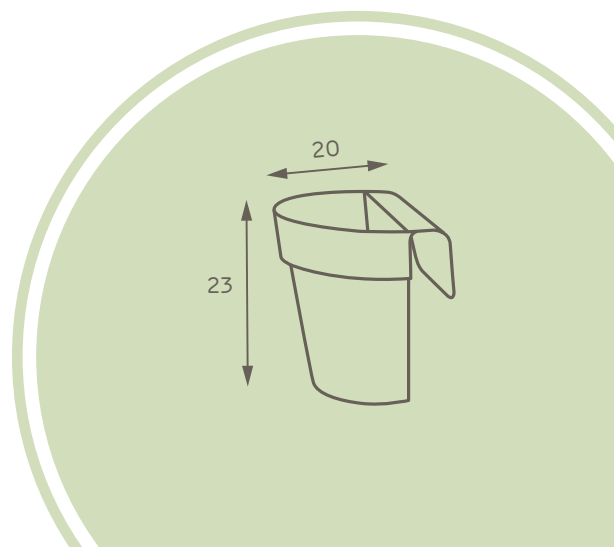



up | cassetta • plant box

art.	size				
3059	cm 50	(cm 50 x 21 x 23 h)	L 9	6	

up

good for plants



pp



display solutions



espositore
display



palbox



3064 global expe
(cm 56 x 56 x 183 h)

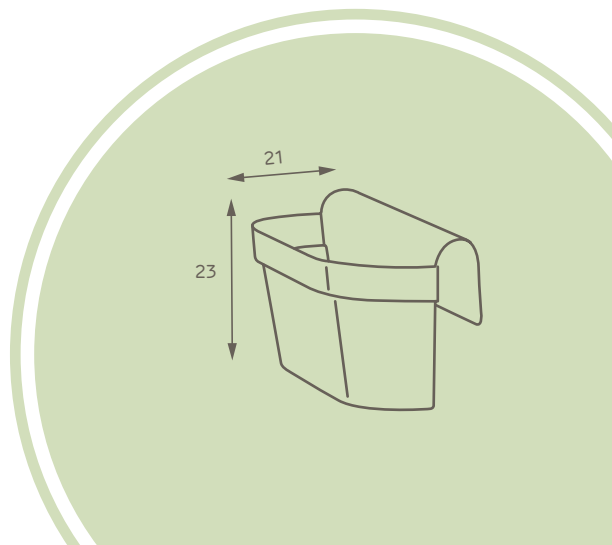



be up | vaso • pot

art.	size				
3032	Ø 25	(cm 33 x 25 x 25 h)	L 8	6	



be up

good for plants



pp



display solutions



espositore
display



palbox



3064 global expe
(cm 56 x 56 x 183 h)

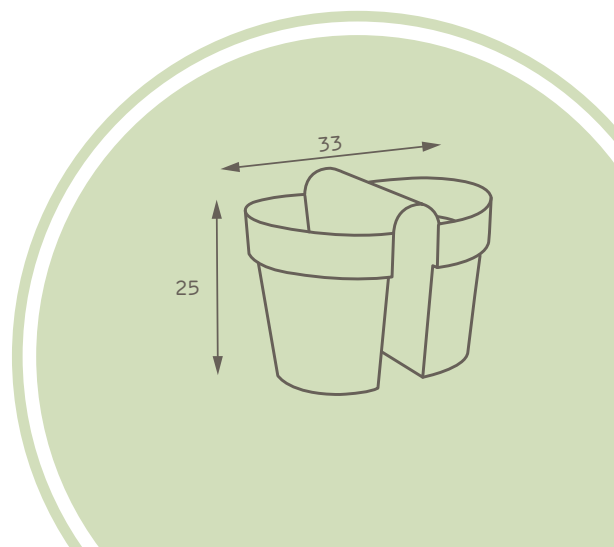



be up | cassetta • plant box

art.	size				
3048	cm 50	(cm 49,5 x 33 x 23 h)	L 18	4	

be up

good for plants



pp



display solutions



espositore display



palbox



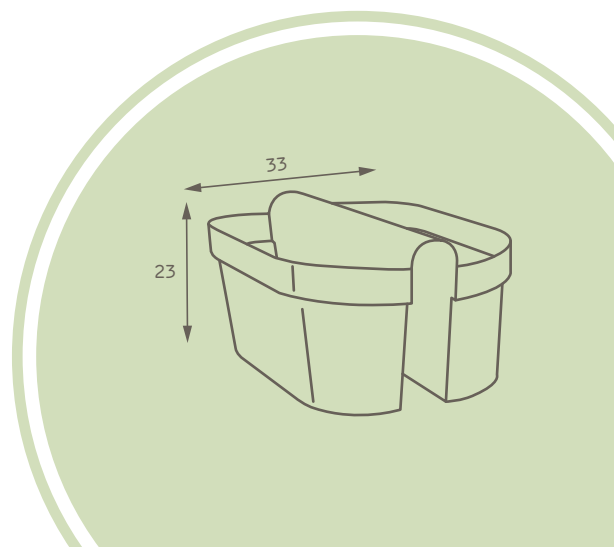

3064 global expe
(cm 56 x 56 x 183 h)





mitu pac | cassetta con fori • plant box with holes

art.	size				
2915	cm 100	(cm 99 x 40 x 40 h)	L 112	2	03 M9 69 62

mitu pac

good for **plants**



pp



cassetta con fori
plant box with holes



sottocassetta abbinata
fitting oblong tray



easy for **sales**



vaso abbinato
matching pot

display solutions





cover pallet

86
87





akea | sottocassetta • oblong tray

art.	size			
1689	cm 100	(cm 90 x 36 x 5,7 h)	2	03 M9 G9 62

molto capiente
very capacious



mitu pac quadro | vaso con fori • pot with holes

art.	size				
2914	cm 40	(cm 40 x 40 x 40 h)	L 41	2	

mitu pac

good for plants



pp



vaso con fori
pot with holes



sottovaso abbinato
fitting saucer



easy for sales



cassetta abbinata
matching plant box



display solutions



cover pallet

88
89

krea | sottovaso quadro • square saucer

art.	size			
1711	cm 45	(cm 36 x 36 x 5,7 h)	5	03 M9 G9 62 L4

molto capiente
very capacious



mitu pac | cassetta con fori • plant box with holes

art.	size				
2886	cm 50	(cm 50 x 18 x 16,5 h)	L 10,5	6	03 M9 G9 62 L4

mitu pac

good for **plants**



pp



cassetta con fori
plant box with holes



sottocassetta abbinata
fitting oblong tray

easy for **sales**





impilabile
stackable



90
91

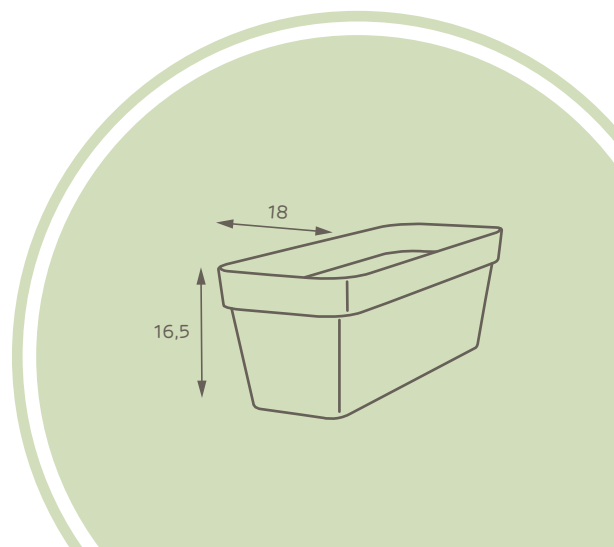

inis | sottocassetta • oblong tray

art.	size			
1991	cm 50	(cm 46,6 x 16,1 x 3 h)	6	03 M9 G9 62 L4





mitu pac | vaso con fori • pot with holes

art.	size				
2888	Ø 14 (cm 14 x 12,5 h)	L 1,1	20	03 M9 G9 62 L4	
2889	Ø 16 (cm 16 x 14,0 h)	L 1,7	20	03 M9 G9 62 L4	
2890	Ø 18 (cm 18 x 16,0 h)	L 2,5	20	03 M9 G9 62 L4	
2878	Ø 20 (cm 20 x 18,0 h)	L 3,4	10	03 M9 G9 62 L4 L2	
2842	Ø 25 (cm 25 x 22,0 h)	L 6,7	5	03 M9 G9 62 L4 L2	
2843	Ø 30 (cm 30 x 27,0 h)	L 11,5	5	03 M9 G9 62 L4 L2	

mitu pac

good for plants



pp



vaso con fori
pot with holes



sottovaso abbinato
fitting saucer



display solutions



espositore
display



3057 total expe
(cm 63 x 123 x 210 h)



2774 mitu
(cm 63 x 46 x 160 h)



medea | sottovaso • saucer

art.	size			
1471	Ø 12 (cm 12,8 x 2,1 h)		5	03 M9 G9 62 L4
1472	Ø 14 (cm 14,3 x 2,4 h)		5	03 M9 G9 62 L4
1473	Ø 16 (cm 15,9 x 2,6 h)		5	03 M9 G9 62 L4
1474	Ø 18 (cm 17,9 x 2,9 h)		5	03 M9 G9 62 L4 L2
1476	Ø 22 (cm 22,0 x 3,6 h)		5	03 M9 G9 62 L4 L2
1478	Ø 26 (cm 26,0 x 3,9 h)		5	03 M9 G9 62 L4 L2



mitu pac | vaso con fori • pot with holes

art.	size				
2844	Ø 35 (cm 35 x 31 h)	L 18,5	5	03 M9 G9 62 L4 L2	
2854	Ø 40 (cm 40 x 36 h)	L 28,0	5	03 M9 G9 62 L4 L2	
2898	Ø 50 (cm 50 x 45 h)	L 55,0	2	03 M9 G9 62 L4 L2	
2879	Ø 60 (cm 60 x 53 h)	L 96,0	2	03 M9 G9 62 L4 L2	
2909	Ø 80 (cm 80 x 71 h)	L 228,0	1	03 M9 G9 62 L4 L2	
2983	Ø 100 (cm 99 x 88 h)	L 436,0	1	03 M9 G9 62 L2	

mitu pac

good for plants



pp



vaso con fori
pot with holes



sottovaso abbinato
fitting saucer



display solutions



espositore
display



3057 total expe
(cm 63 x 123 x 210 h)



94
95





medea | sottovaso • saucer

art.	size			
1480	Ø 30	(cm 30 x 4,4 h)	5	03 M9 G9 62 L4 L2
1482	Ø 36	(cm 36 x 5,0 h)	5	03 M9 G9 62 L4 L2
1484	Ø 44	(cm 44 x 5,8 h)	2	03 M9 G9 62 L4 L2
1486	Ø 52	(cm 52 x 6,7 h)	2	03 M9 G9 62 L4 L2
1488	Ø 64	(cm 64 x 7,0 h)	1	03 M9 G9 62 L4 L2
1960	Ø 82	(cm 82 x 8,7 h)	1	03 M9 G9 62 L2



grande
dimensione
large



clivo satin | vaso con fori • pot with holes

art.	size					
3182	Ø 14	(cm 14 x 14 h)	L 1,4	24	98	
3183	Ø 16	(cm 16 x 16 h)	L 2,2	24	98	
3184	Ø 18	(cm 18 x 18 h)	L 3,1	24	98	

satin | sottovaso • saucer

art.	size				
3185	Ø 12	(cm 12,5 x 2,4 h)	24		98
3186	Ø 14	(cm 14 x 2,8 h)	24		98
3187	Ø 16	(cm 16 x 3 h)	24		98

clivo satin

good for **plants**



pp



sottovaso abbinato
fitting saucer



display solutions



espositore
display



96
97



ideale per
orchidee
ideal for
orchids



clivo orchidea satin | vaso senza fori • pot without holes

art.	size					
3188	Ø 12,5	(cm 12,5 x 15 h)	L 1,1	24	98	

clivo orchidea satin

good for plants



pp



coprivaso
cachepot



display solutions



espositore
display





98
99



ideale per
orchidee
ideal for
orchids



clivo satin | cassetta • plant box

art.	size				
3190	cm 28	(cm 28,5 x 13 x 12 h)	L 3	12	98

clivo satin

good for plants



pp



coprivaso
cachepot



display solutions





espositore
display





liken | vaso • pot

art.	size				
3028	Ø 27 (cm 27 x 36 h)	L 13	5	03 M9 G9 62 L2	
3029	Ø 34 (cm 34 x 46 h)	L 26	5	03 M9 G9 62 L2	
3030	Ø 41 (cm 41 x 55 h)	L 45	5	03 M9 G9 62 L2	



liken

good for **plants**



pp



coprivaso
cachepot



easy for **sales**



impilabile
stackable



miu | vaso • pot

art.	size				
2839	Ø 7	(cm 7 x 6,4 h)	L 0,20	12	03 M9
2840	Ø 9	(cm 9 x 8,2 h)	L 0,45	12	03 M9

miu

good for plants



pp



coprivaso
cachepot



display solutions



espositore
display











104
105

ideale per
piante grasse
ideal for
succulent plants



synue | vaso • pot

art.	size				
2551	Ø 14 (cm 14 x 12,5 h)	L 1,4	24		
2552	Ø 16 (cm 16 x 14,5 h)	L 2,0	24		
2553	Ø 18 (cm 18 x 16,0 h)	L 2,9	24		



synue

good for plants



pp



coprivaso
cachepot





display solutions



espositore
display



quadria | vaso • pot

art.	size				
2554	cm 14	(cm 14 x 14 x 12,5 h)	L 1,7	24	03 44
2555	cm 16	(cm 16 x 16 x 14,5 h)	L 2,5	24	03 44
2556	cm 18	(cm 18 x 18 x 16,0 h)	L 3,6	24	03 44



quadria

good for plants



pp



coprivaso
cachepot

display solutions



espositore
display





style



100%
Recyclable



Lightweight



Antishock



U.V.
Resistant



Temperature
Resistant



kube | cassetta • plant box

art.	size						
2601	cm 80	(cm 80 x 30 x 30 h)	L 32	A4327	2 x A4629	1	        
2548	cm 100	(cm 100 x 40 x 40 h)	L 73	A4278	2 x A4629	1	        

kube | cassetta con ruote • plant box with castors

art.	size					
2753	cm 80	(cm 80 x 30 x 31 h)	L 32	A4327	1	        
2590	cm 100	(cm 100 x 40 x 41 h)	L 73	A4278	1	        



kube

good for plants



lhdpe



kit riserva d'acqua
water reserve kit

easy for sales



rifinito a mano
hand-finished



cassetta vaso abbinati
matching plant box pot



kit fissaggio a terra
ground fixing kit

display solutions



cover pallet

112
113

kube | vaso • pot

art.	size						
2538	cm 30	(cm 30 x 30 x 30 h)	L 9	A4255	A4629	1	
2514	cm 40	(cm 40 x 40 x 40 h)	L 22	A4241	A4629	1	
2515	cm 50	(cm 50 x 50 x 50 h)	L 45	A4242	A4629	1	













kube | vaso con ruote • pot with castors

art.	size					
2587	cm 30	(cm 30 x 30 x 31 h)	L 9	A4255	1	
2588	cm 40	(cm 40 x 40 x 41 h)	L 22	A4241	1	
2589	cm 50	(cm 50 x 50 x 51 h)	L 45	A4242	1	

anche con
ruote nascoste
also with
hidden castors



kube gloss | vaso • pot

art.	size								
*2583	cm 30	(cm 30 x 30 x 30 h)	L 9	A4255	A4629	1			
*2584	cm 40	(cm 40 x 40 x 40 h)	L 22	A4241	A4629	1			
*2585	cm 50	(cm 50 x 50 x 50 h)	L 45	A4242	A4629	1			

* per quantitativi minimi • for minimum orders



kube

gloss

good for plants



lلدpe



kit riserva d'acqua
water reserve kit

easy for sales



rifinito a mano
hand-finished



kit fissaggio a terra
ground fixing kit



kube mini | cassetta • plant box

art.	size					
2828	cm 50	(cm 50 x 18 x 18 h)	L 9,0	A4629	1	 
2776	cm 60	(cm 60 x 20 x 20 h)	L 11,5	A4629	1	 

kube mini

good for plants



lldpe



easy for sales



rifinito a mano
hand-finished



kit fissaggio a terra
ground fixing kit



116
117

kube mini | vaso • pot

art.	size					
2827	cm 18	(cm 18 x 18 x 18 h)	L 2,7	A4629	1	
2634	cm 20	(cm 20 x 20 x 20 h)	L 2,7	A4629	1	



kube mini | cassetta • plant box with mini led light kit (indoor)

art.	size		
2791	cm 60	(cm 60 x 20 x 20 h)	1 

kube mini

light

material



HDPE



easy for sales



rifinito a mano
hand-finished



kit luce montato
installed light kit



118
119

kube mini | vaso • pot with mini led light kit (indoor)

art.	size			
2783	cm 20	(cm 20 x 20 x 20 h)	1	(98)



kube high | cassetta alta • high plant box

art.	size						
2602	cm 80	(cm 80 x 30 x 70 h)	L 32,0	A4327	2 x A4629	1	        
2586	cm 100	(cm 100 x 40 x 70 h)	L 77,5	A4278	2 x A4629	1	        

kube high | cassetta alta con ruote • high plant box with castors

art.	size					
2754	cm 80	(cm 80 x 30 x 71 h)	L 32,0	A4327	1	        
2591	cm 100	(cm 100 x 40 x 71 h)	L 77,5	A4278	1	        



kube high

good for plants



100%
lلدپه



kit riserva d'acqua
water reserve kit

easy for sales



rifinito a mano
hand-finished



cassetta vaso abbinati
matching plant box pot



kit fissaggio a terra
ground fixing kit

display solutions



cover pallet

120
121

kube high | vaso alto • high pot

art.	size						
2611	cm 30	(cm 30 x 30 x 70 h)	L 9	A4255	A4629	1	
2612	cm 40	(cm 40 x 40 x 70 h)	L 23	A4241	A4629	1	



kube high | vaso alto con ruote • high pot with castors

art.	size					
2733	cm 30	(cm 30 x 30 x 71 h)	L 9	A4255	1	
2734	cm 40	(cm 40 x 40 x 71 h)	L 23	A4241	1	



anche con
ruote nascoste
also with
hidden castors



kube high | cass. alta • high plant box light (indoor)

art.	size				
2745	cm 80	(cm 80 x 30 x 70 h)	2 x A4629	1	98
2701	cm 100	(cm 100 x 40 x 70 h)	2 x A4629	1	98

kube high | cass. alta • high plant box light (outdoor)

art.	size				
*2746	cm 80	(cm 80 x 30 x 70 h)	2 x A4629	1	98
*2702	cm 100	(cm 100 x 40 x 70 h)	2 x A4629	1	98

* con canaletta di scolo • with drainage tube

kube high

light

material



lldpe



easy for sales



rifinito a mano
hand-finished



cassetta vaso abbinati
matching plant box pot



kit fissaggio a terra
ground fixing kit



kit luce montato
installed light kit



122
123

kube high | vaso alto • high pot light (indoor)

art.	size				
2737	cm 30	(cm 30 x 30 x 70 h)	A4629	1	98
2741	cm 40	(cm 40 x 40 x 70 h)	A4629	1	98

kube high | vaso alto • high pot light (outdoor)

art.	size				
2738	cm 30	(cm 30 x 30 x 70 h)	A4629	1	98
*2742	cm 40	(cm 40 x 40 x 70 h)	A4629	1	98

* con canaletta di scolo • with drainage tube



kube high slim | cassetta alta • high plant box

art.	size						
2777	cm 80	(cm 80 x 25 x 70 h)	L 32	A4327	2 x A4629	1	Ⓢ2 Ⓢ9 Ⓢ3 Ⓢ4 Ⓢ7 Ⓢ5

kube high slim

good for plants



lIdpe



kit riserva d'acqua
water reserve kit



easy for sales



rifinito a mano
hand-finished



cassetta vaso abbinati
matching plant box pot



kit fissaggio a terra
ground fixing kit

display solutions



cover pallet



124
125

kube high slim | vaso alto • high pot



art.	size						
2788	cm 25	(cm 25 x 25 x 70 h)	L 8,8	A4255	A4629	1	



kube high slim | cass. alta • high plant box light (indoor)

art.	size				
2792	cm 80	(cm 80 x 25 x 70 h)	2 x A4629	1	98

kube high slim | cass. alta • high plant box light (outdoor)

art.	size				
*2793	cm 80	(cm 80 x 25 x 70 h)	2 x A4629	1	98

* con canaletta di scolo • with drainage tube

kube high slim

light

material



lhdpe

easy for sales



rifinito a mano
hand-finished



cassetta vaso abbinati
matching plant box pot



kit fissaggio a terra
ground fixing kit



kit luce montato
installed light kit

126
127

kube high slim | vaso alto • high pot (indoor)

art.	size				
2796	cm 25	(cm 25 x 25 x 70 h)	A4629	1	98

kube high slim | vaso alto • high pot light (outdoor)

art.	size				
2797	cm 25	(cm 25 x 25 x 70 h)	A4629	1	98



kube tower | cassetta alta • high plant box

art.	size						
2825	cm 70	(cm 70 x 30 x 90 h)	L 29	A4327	2 x A4629	1	©2 G9 S3 S4 87 E5



kube tower

good for plants



100%
lIdpe



kit riserva d'acqua
water reserve kit



easy for sales



rifinito a mano
hand-finished



cassetta vaso abbinati
matching plant box pot



kit fissaggio a terra
ground fixing kit

display solutions



cover pallet



128
129

kube tower | vaso alto • high pot

art.	size						
2826	cm 30	(cm 30 x 30 x 90 h)	L 10	A4255	A4629	1	     



kube tower | cass. alta • high plant box light (indoor)

art.	size				
2835	cm 70	(cm 70 x 30 x 90 h)	2 x A4629	1	98

kube tower | cass. alta • high plant box light (outdoor)

art.	size				
*2836	cm 70	(cm 70 x 30 x 90 h)	2 x A4629	1	98

* con canaletta di scolo • with drainage tube



kube tower

light

material



lIdpe

easy for sales



rifinito a mano
hand-finished



cassetta vaso abbinati
matching plant box pot



kit fissaggio a terra
ground fixing kit



kit luce montato
installed light kit

130
131

kube tower | vaso alto • high pot light (indoor)

art.	size				
2831	cm 30	(cm 30 x 30 x 90 h)	A4629	1	98

kube tower | vaso alto • high pot light (outdoor)

art.	size				
2832	cm 30	(cm 30 x 30 x 90 h)	A4629	1	98



kube | panca • bench

art.	size				
2549	cm 100	(cm 100 x 40 x 40 h)	2 x A4629	1	©2 87 E5

kube

material



lIdpe

easy for sales



rifinito a mano
hand-finished



kit fissaggio a terra
ground fixing kit



132
133

kube | sgabello • stool

art.	size				
2532	cm 40	(cm 40 x 40 x 40 h)	A4629	1	
*2533	cm 50	(cm 50 x 50 x 50 h)	A4629	1	

* per quantitativi minimi • for minimum orders



kuba | panca • bench light (indoor)

art.	size				
2755	cm 100	(cm 100 x 40 x 40 h)	2 x A4629	1	98

kuba | panca • bench light (outdoor)

art.	size				
2756	cm 100	(cm 100 x 40 x 40 h)	2 x A4629	1	98

kube

light

material



HDPE



easy for sales



rifinito a mano
hand-finished



kit fissaggio a terra
ground fixing kit



kit luce montato
installed light kit



134
135

kube | sgabello • stool light (indoor)

art.	size				
2705	cm 40	(cm 40 x 40 x 40 h)	A4629	1	98
2708	cm 50	(cm 50 x 50 x 50 h)	A4629	1	98

kube | sgabello • stool light (outdoor)

art.	size				
2706	cm 40	(cm 40 x 40 x 40 h)	A4629	1	98
2709	cm 50	(cm 50 x 50 x 50 h)	A4629	1	98



kube mini | cubo • cube with mini led light kit (indoor)

art.	size		
2784	cm 20	(cm 20 x 20 x 20 h)	1 



kube mini

light

material



lIdpe

easy for **sales**















rifinito a mano
hand-finished



kit luce montato
installed light kit



ikon | vaso • pot

art.	size						
2603	Ø 40	(cm 40 x 36 h)	L 23			1	
2604	Ø 50	(cm 50 x 44 h)	L 47			1	
2605	Ø 60	(cm 60 x 53 h)	L 82	1 x A4631		1	
2896	Ø 70	(cm 70 x 62 h)	L 130	1 x A4631		1	
2541	Ø 80	(cm 80 x 71 h)	L 202	1 x A4631		1	
2542	Ø 100	(cm 100 x 89 h)	L 398	2 x A4631		1	
2543	Ø 120	(cm 120 x 107 h)	L 680	2 x A4631		1	
*2786	Ø 140	(cm 140 x 125 h)	L1066			1	
*2787	Ø 160	(cm 160 x 143 h)	L1594			1	

*Articolo con disponibilità limitata e tempi di produzione lunghi • Item with low availability and long production delays



ikon

good for plants



lhdpe



sottovaso abbinato
fitting saucer



easy for sales



rifinito a mano
hand-finished



kit fissaggio a terra
ground fixing kit



display solutions



cover pallet

138
139

ikon | sottovaso • saucer

art.	size			
2607	Ø 50	(cm 36,0 x 3,5 h)	1	C2 M9 G9 S3 S4 87 E5
2608	Ø 60	(cm 42,5 x 4,0 h)	1	C2 M9 G9 S3 S4 87 E5
2897	Ø 70	(cm 50,5 x 4,5 h)	1	C2 M9 G9 S3 S4 87 E5
2598	Ø 80	(cm 56,0 x 5,0 h)	1	C2 M9 G9 S3 S4 87 E5
2599	Ø 100	(cm 71,0 x 6,0h)	1	C2 M9 G9 S3 S4 87 E5
2600	Ø 120	(cm 85,0 x 7,0 h)	1	C2 M9 G9 87 E5
2814	Ø 140	(cm 99,0 x 8,5 h)	1	C2 G9 87 E5
2815	Ø 160	(cm 113,0 x 9,5 h)	1	C2 G9 87 E5

i sottovasi possono essere ordinati solo contestualmente ai vasi cui sono abbinati e in quantità uguale, inferiore o secondo la disponibilità • these saucers may only be ordered at the same time as the pots they are matched to, and in the same or fewer quantities, depending on availability



ikon | vaso con fori • pot with holes

art.	size				
*2996	Ø 200 (cm 200 x 178 h)	L 3139	1		Ⓢ Ⓜ Ⓡ ⓔ

ikon | sottovaso • saucer

art.	size			
3008	Ø 200 (cm 141 x 12 h)	1		Ⓢ Ⓜ Ⓡ ⓔ

*Articolo con disponibilità limitata e tempi di produzione lunghi • Item with low availability and long production delays



ikon

good for plants



lلدpe



sottovaso abbinato
fitting saucer



easy for sales



rifinito a mano
hand-finished

140
141

ikon | vaso con fori chiuso sopra • pot with holes closed on top

art.	size				
*3012	Ø 200	(cm 200x178 h)	L 767	1	ⓐ2 ⓑ9 Ⓒ87 Ⓓ5

i sottovasi possono essere ordinati solo contestualmente ai vasi cui sono abbinati e in quantità uguale, inferiore o secondo la disponibilità • these saucers may only be ordered at the same time as the pots they are matched to, and in the same or fewer quantities, depending on availability

grande
dimensione
large

etria

good for plants



lldpe

easy for sales



rifinito a mano
hand-finished

display solutions



cover pallet



etria | vaso con doppia parete • pot with double wall

art.	size				
2453	Ø 24 (cm 24 x 20 h)	L 5	1		(C2) (M9) (87) (E5) (45) (69)
2318	Ø 34 (cm 34 x 28 h)	L 14	1		(C2) (M9) (G9) (87) (E5) (45) (69)
2319	Ø 44 (cm 44 x 36 h)	L 30	1		(C2) (M9) (G9) (87) (E5) (45) (69)
2320	Ø 54 (cm 54 x 44 h)	L 56	1		(C2) (M9) (G9) (87) (E5) (45) (69)
2447	Ø 64 (cm 64 x 52 h)	L 86	1		(C2) (M9) (G9) (87) (E5) (45)
2454	Ø 74 (cm 74 x 61 h)	L 131	1		(C2) (M9) (G9) (87) (E5)



etria uno

good for plants



lldpe



easy for sales



rifinito a mano
hand-finished



display solutions



cover pallet

















142
143

etria uno | vaso con singola parete • pot with single wall

art.	size				
2860	Ø 24 (cm 24 x 20 h)	L 6	1		    
2861	Ø 34 (cm 34 x 28 h)	L 18	1		    
2862	Ø 44 (cm 44 x 36 h)	L 39	1		    
2863	Ø 54 (cm 54 x 44 h)	L 73	1		    
2864	Ø 64 (cm 64 x 52 h)	L 123	1		    
2865	Ø 74 (cm 74 x 61 h)	L 192	1		    



ilie | vaso • pot

art.	size						
2497	Ø 37 (cm 37 x 75 h)		L 13	A4256		1	  
2498	Ø 42 (cm 42 x 90 h)		L 19			1	  
2415	Ø 47 (cm 47 x 98 h)		L 26	A4239	A4631	1	  
2506	Ø 57 (cm 57 x 126 h)		L 54	A4240		1	  

ilie

good for **plants**



lلدpe



kit riserva d'acqua
water reserve kit



easy for **sales**



rifinito a mano
hand-finished



kit fissaggio a terra
ground fixing kit





ilie gloss | vaso • pot

art.	size						
2579	Ø 32	(cm 32 x 67 h)	L 9		A4631	1	Ⓒ2
2509	Ø 37	(cm 37 x 75 h)	L 13	A4256		1	Ⓒ2
2518	Ø 47	(cm 47 x 98 h)	L 26	A4239	A4631	1	Ⓒ2

ilie

gloss

good for **plants**



100%
lldpe



kit riserva d'acqua
water reserve kit



easy for **sales**



rifinito a mano
hand-finished





kit fissaggio a terra
ground fixing kit







ilie | vaso • pot light (indoor)

art.	size				
2661	Ø 37 (cm 37 x 75 h)			1	98
2665	Ø 42 (cm 42 x 90 h)			1	98
2669	Ø 47 (cm 47 x 98 h)		A4631	1	98
2673	Ø 57 (cm 57 x 126 h)			1	98

ilie | vaso • pot light (outdoor)

art.	size				
2662	Ø 37 (cm 37 x 75 h)			1	98
2666	Ø 42 (cm 42 x 90 h)			1	98
2670	Ø 47 (cm 47 x 98 h)		A4631	1	98
2674	Ø 57 (cm 57 x 126 h)			1	98

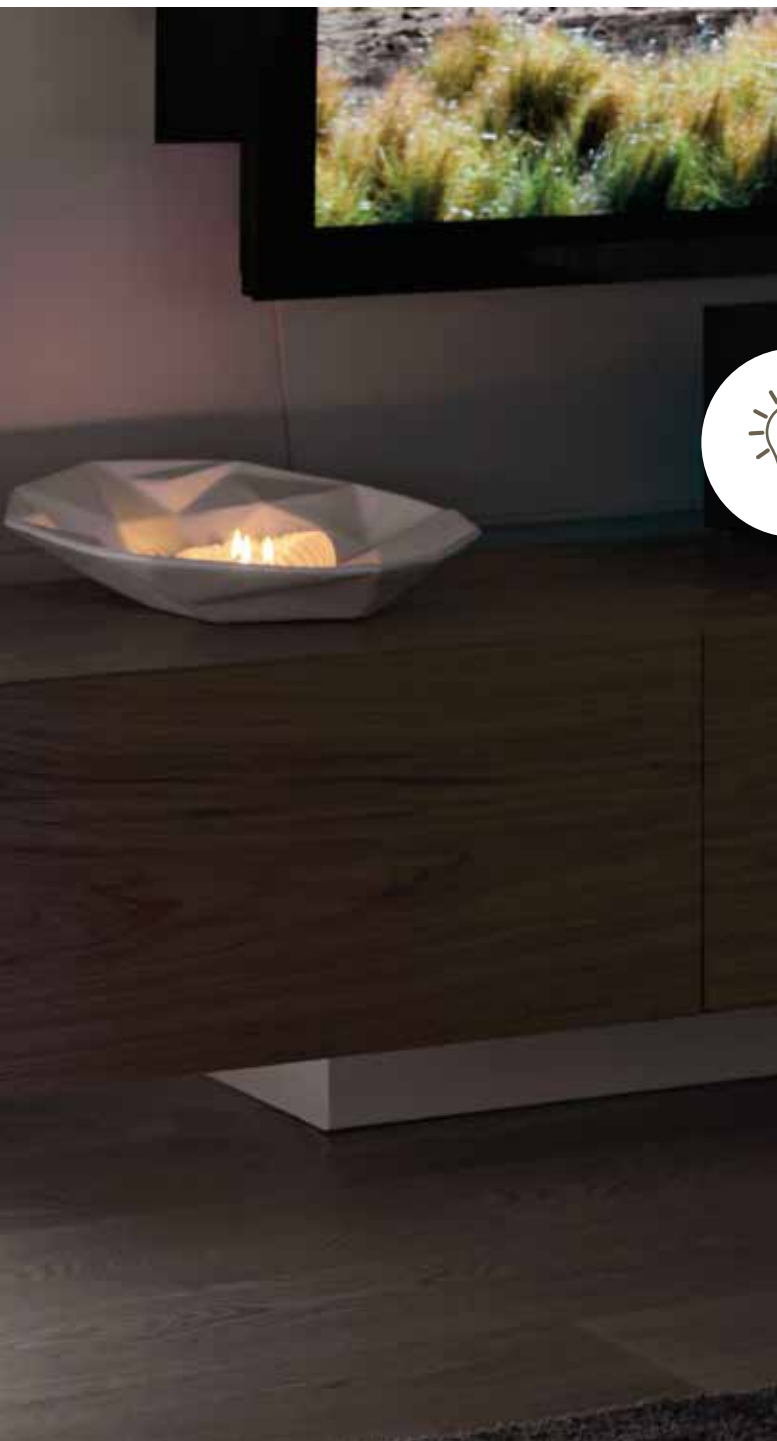

ilie light

material



lIdpe

easy for **sales**



rifinito a mano
hand-finished











kit fissaggio a terra
ground fixing kit



kit luce montato
installed light kit



kiam | vaso quadro • square pot

art.	size				
2499	cm 35	(cm 35 x 35 x 75 h)	L 13	1	  
2500	cm 40	(cm 40 x 40 x 90 h)	L 20	1	  



kiam

good for plants



lhdpe





easy for sales



rifinito a mano
hand-finished



kiam gloss | vaso quadro • square pot

art.	size						
2581	cm 30	(cm 30 x 30 x 67 h)	L 9,0	A4255	A4629	1	Ⓢ
2638	cm 35	(cm 35 x 35 x 75 h)	L 14,0	A4373		1	Ⓢ
2582	cm 40	(cm 40 x 40 x 90 h)	L 23,0	A4241	A4629	1	Ⓢ



kiam

gloss

good for **plants**



HDPE



kit riserva d'acqua
water reserve kit

easy for **sales**





rifinito a mano
hand-finished





kit fissaggio a terra
ground fixing kit



kiam | vaso quadro • square pot light (indoor)

art.	size			
2693	cm 35	(cm 35 x 35 x 75 h)	1	98
2697	cm 40	(cm 40 x 40 x 90 h)	1	98

kiam | vaso quadro • square pot light (outdoor)

art.	size			
2694	cm 35	(cm 35 x 35 x 75 h)	1	98
2698	cm 40	(cm 40 x 40 x 90 h)	1	98



kiam

light

material



lldpe

easy for **sales**







rifinito a mano
hand-finished



kit luce montato
installed light kit



kuno gloss | vaso • pot

art.	size						
2536	Ø 40	(cm 40 x 40 h)	L 14	A4256	A4631	1	Ⓒ2
2534	Ø 50	(cm 50 x 50 h)	L 28	A4239	A4631	1	Ⓒ2
2535	Ø 60	(cm 60 x 60 h)	L 52	A4240	A4631	1	Ⓒ2

kuno

gloss

good for **plants**



HDPE



kit riserva d'acqua
water reserve kit



easy for **sales**



rifinito a mano
hand-finished







kit fissaggio a terra
ground fixing kit





quadrum | vaso quadro • square pot

art.	size					
*2419	cm 37	(cm 37 x 37 x 73 h)	L 16	A4629	1	87 69
*2420	cm 51	(cm 51 x 51 x 100 h)	L 41	A4629	1	87 69

* per quantitativi minimi • for minimum orders



quadrum

good for plants



lلدpe



easy for sales







rifinito a mano
hand-finished



kit fissaggio a terra
ground fixing kit



tulum | vaso • pot

art.	size					
*2373	Ø 35	(cm 35 x 51 h)	L 18	A4629	1	87
2374	Ø 43	(cm 43 x 63 h)	L 33	A4629	1	87
2375	Ø 56	(cm 56 x 102 h)	L 91	A4629	1	87

* per quantitativi minimi • for minimum orders

tulum

good for plants



HDPE



easy for sales



rifinito a mano
hand-finished





kit fissaggio a terra
ground fixing kit





akan | cassetta • plant box

art.	size				
*2465	cm 80	(cm 80 x 40 x 33 h)	L 60	1	87 E5

* per quantitativi minimi • for minimum orders

akan

good for plants



llDpe



easy for sales



rifinito a mano
hand-finished



cassetta vaso abbinati
matching plant box pot



162
163



akan | vaso quadro • square pot

art.	size				
*2486	cm 40	(cm 40 x 40 x 33 h)	L 25	1	87 E5

* per quantitativi minimi • for minimum orders



sfera | sphere light (outdoor)

art.	size			
2651	Ø 45	(cm 45 x 40 h)	1	98
2716	Ø 55	(cm 55 x 50 h)	1	98
2719	Ø 65	(cm 65 x 60 h)	1	98

sfera

light

material



lldpe

easy for sales



rifinito a mano
hand-finished





kit luce montato
installed light kit



164
165

sfera a sospensione | suspended sphere light (indoor/outdoor)

art.	size			
3023	Ø 45 (cm 45 x 40 h)	1	1	98
3024	Ø 55 (cm 55 x 50 h)	1	1	98
3025	Ø 65 (cm 65 x 60 h)	1	1	98



sfera con piedistallo | sphere with pedestal light (outdoor)

art.	size		
2760	Ø 65	(cm 65 x 70 h)	1
			98



sfera

light

material



lIdpe

easy for **sales**



rifinito a mano
hand-finished



kit luce montato
installed light kit



sfera mini | mini sphere with led light kit (indoor)

art.	size		
2636	Ø 20	(cm 20 x 18 h)	1
			



sfera mini

light

material



lldpe

easy for **sales**













rifinito a mano
hand-finished













kit luce montato
installed light kit



siepi | cassetta • plant box

art.	size				
2234	cm 80	(cm 80 x 39 x 35 h)	L 76	1	   
2217	cm 100	(cm 99 x 47 x 41 h)	L 157	1	   

millerighe | sottocassetta • oblong tray

art.	size			
1887	cm 80	(cm 81 x 40 x 4 h)	1	   
1883	cm 100	(cm 100 x 47 x 4 h)	1	   



siepi

good for plants



lIdpe



sottocassetta abbinata
fitting oblong tray



sottovaso abbinato
fitting saucer



easy for sales













rifinito a mano
hand-finished









cassetta vaso abbinati
matching plant box pot

170
171

siepi | vaso quadro • square pot

art.	size				
2235	cm 39	(cm 39 x 39 x 35 h)	L 32	1	   
2216	cm 47	(cm 47 x 47 x 41 h)	L 71	1	   

neze | sottovaso quadro • square saucer

art.	size			
1630	cm 42	(cm 42 x 42 x 5,2 h)	1	 
1631	cm 48	(cm 49 x 49 x 5,6 h)	1	 



siepi | cassetta con doppia parete • plant box with double wall

art.	size				
2376	cm 120	(cm 120 x 55 x 48 h)	L 198	1	69 87 45

siepi | sottocassetta • oblong tray

art.	size			
2383	cm 120	(cm 127 x 61 x 6,8 h)	1	69 87 45

siepi

good for plants



IlDpe



sottocassetta abbinata
fitting oblong tray



sottovaso abbinato
fitting saucer



easy for sales



rifinito a mano
hand-finished



cassetta vaso abbinati
matching plant box pot



172
173

siepi | vaso quadro con doppia parete • square pot with double wall

art.	size				
2288	cm 55	(cm 55 x 55 x 48 h)	L 78	1	G9 87 45
2317	cm 71	(cm 71 x 71 x 62 h)	L 171	1	G9 87 45

neze | sottovaso quadro • square saucer



art.	size			
2093	cm 61	(cm 61 x 61 x 6,8 h)	1	87 45
2095	cm 74	(cm 74 x 74 x 8,0 h)	1	87 45

con doppia
parete



with double
wall



siepi | vaso • pot

art.	size				
*2309	Ø 38	(cm 38 x 35 h)	L 30	1	45
*2310	Ø 47	(cm 47 x 41 h)	L 55	1	45
*2311	Ø 52	(cm 52 x 56 h)	L 97	1	45

idria | sottovaso • saucer

art.	size			
1550	Ø 47	(cm 47 x 5,5 h)	1	45
1552	Ø 56	(cm 56 x 6,0 h)	1	45
1553	Ø 63	(cm 63 x 7,0 h)	1	45



siepi | vaso a muro • wall pot

art.	size				
*2289	cm 52	(cm 52 x 27 x 56 h)	L 53	1	45

sottovaso a muro | sottovaso a muro • wall saucer

art.	size			
*1544	cm 57	(cm 57 x 34 x 4,5 h)	1	45

ulivum

good for plants



100%
HDPE



sottovaso abbinato
fitting saucer



easy for sales



rifinito a mano
hand-finished



ulivum | conca • conch

art.	size				
2173	Ø 115	(cm 115 x 81 h)	L 555	1	45
2121	Ø 148	(cm 148 x 96 h)	L 1100	1	45

ulivum | sottovaso • saucer

art.	size			
2174	Ø 115	(cm 90 x 6 h)	1	45
2127	Ø 148	(cm 118 x 7 h)	1	45

i sottovasi possono essere ordinati solo contestualmente ai vasi cui sono abbinati e in quantità uguale, inferiore o secondo la disponibilità • these saucers may only be ordered at the same time as the pots they are matched to, and in the same or fewer quantities, depending on availability



doppio bordo

good for **plants**



lldpe



sottovaso abbinato
fitting saucer

easy for **sales**





rifinito a mano
hand-finished





impilabile
stackable

176
177

doppio bordo | vaso • pot

art.	size				
1746	Ø 35	(cm 35 x 32 h)	L 15	1	45
1747	Ø 40	(cm 42 x 37 h)	L 24	1	45
1748	Ø 45	(cm 45 x 40 h)	L 32	1	45
1749	Ø 50	(cm 51 x 44 h)	L 44	1	45
1750	Ø 55	(cm 55 x 47 h)	L 60	1	45
1751	Ø 60	(cm 60 x 51 h)	L 77	1	45
1752	Ø 65	(cm 65 x 56 h)	L 100	1	45
1753	Ø 75	(cm 77 x 61 h)	L 150	1	45
1754	Ø 85	(cm 85 x 68 h)	L 210	1	45

doppio bordo | sottovaso • saucer

art.	size			
1790	Ø 25	(cm 26 x 3,6 h)	1	45
1791	Ø 30	(cm 30 x 3,5 h)	1	45
1792	Ø 33	(cm 33 x 3,3 h)	1	45
1793	Ø 36	(cm 37 x 3,9 h)	1	45
1794	Ø 40	(cm 41 x 4,0 h)	1	45
1795	Ø 43	(cm 44 x 4,2 h)	1	45
1796	Ø 49	(cm 49 x 4,5 h)	1	45
1797	Ø 54	(cm 54 x 5,0 h)	1	45
1798	Ø 61	(cm 61 x 5,0 h)	1	45

i sottovasi possono essere ordinati solo contestualmente ai vasi cui sono abbinati e in quantità uguale, inferiore o secondo la disponibilità • these saucers may only be ordered at the same time as the pots they are matched to, and in the same or fewer quantities, depending on availability

festonato

good for plants



100%
lldpe



sottovaso abbinato
fitting saucer

easy for sales



rifinito a mano
hand-finished



impilabile
stackable



festonato | vaso • pot

art.	size				
1712	Ø 40	(cm 39 x 32 h)	L 20	1	45
1713	Ø 45	(cm 46 x 37 h)	L 27	1	45
1714	Ø 50	(cm 50 x 39 h)	L 38	1	45
1715	Ø 55	(cm 55 x 45 h)	L 53	1	45
2171	Ø 60	(cm 60 x 48 h)	L 71	1	45
1716	Ø 65	(cm 64 x 52 h)	L 91	1	45
1717	Ø 70	(cm 69 x 57 h)	L 118	1	45
1718	Ø 75	(cm 75 x 60 h)	L 146	1	45
1729	Ø 85	(cm 85 x 68 h)	L 215	1	45
1730	Ø 95	(cm 94 x 77 h)	L 304	1	45
1731	Ø 110	(cm 106 x 85 h)	L 401	1	45

eur | sottovaso • saucer

art.	size			
1719	Ø 28	(cm 28 x 3,3 h)	1	45
1720	Ø 32	(cm 32 x 3,6 h)	1	45
1721	Ø 35	(cm 35 x 3,8 h)	1	45
1722	Ø 37	(cm 37 x 4,3 h)	1	45
2172	Ø 43	(cm 43 x 5,0 h)	1	45
1723	Ø 45	(cm 46 x 4,7 h)	1	45
1724	Ø 50	(cm 50 x 4,8 h)	1	45
1725	Ø 54	(cm 54 x 5,4 h)	1	45
1732	Ø 62	(cm 62 x 5,9 h)	1	45
1733	Ø 68	(cm 68 x 6,1 h)	1	45
1734	Ø 73	(cm 73 x 7,3 h)	1	45

i sottovasi possono essere ordinati solo contestualmente ai vasi cui sono abbinati e in quantità uguale, inferiore o secondo la disponibilità • these saucers may only be ordered at the same time as the pots they are matched to, and in the same or fewer quantities, depending on availability



festum

good for plants



lldpe



easy for sales





rifinito a mano
hand-finished



impilabile
stackable

festum | vaso • pot

art.	size				
2365	Ø 40	(cm 40 x 33 h)	L 23	1	45
2366	Ø 45	(cm 45 x 37 h)	L 33	1	45
2367	Ø 50	(cm 50 x 41 h)	L 46	1	45
2368	Ø 55	(cm 55 x 46 h)	L 61	1	45
2369	Ø 60	(cm 60 x 50 h)	L 79	1	45
2370	Ø 65	(cm 65 x 54 h)	L 100	1	45

cilindro rot

good for plants



lldpe



sottovaso abbinato
fitting saucer



easy for sales



rifinito a mano
hand-finished



impilabile
stackable



cilindro rot | vaso • pot

art.	size				
2294	Ø 50	(cm 52 x 38 h)	L 50	1	G9 45
2165	Ø 60	(cm 62 x 43 h)	L 80	1	G9 45
2164	Ø 70	(cm 72 x 50 h)	L 130	1	G9 45
2163	Ø 90	(cm 90 x 63 h)	L 260	1	G9 45
*2162	Ø 110	(cm 110 x 77 h)	L 480	1	G9 45
*2161	Ø 130	(cm 130 x 91 h)	L 800	1	G9 45
*2151	Ø 150	(cm 150 x 102 h)	L 1150	1	G9 45

cilindro | sottovaso • saucer

art.	size			
2296	Ø 50	(cm 43,5 x 4,3 h)	1	45
2170	Ø 60	(cm 51,0 x 4,4 h)	1	45
2169	Ø 70	(cm 62,0 x 4,7 h)	1	45
2168	Ø 90	(cm 75,0 x 5,6 h)	1	45
*2167	Ø 110	(cm 91,0 x 6,2 h)	1	45
*2166	Ø 130	(cm 107,0 x 6,9 h)	1	45
*2156	Ø 150	(cm 121,0 x 7,5 h)	1	45

* per quantitativi minimi • for minimum orders

i sottovasi possono essere ordinati solo contestualmente ai vasi cui sono abbinati e in quantità uguale, inferiore o secondo la disponibilità • these saucers may only be ordered at the same time as the pots they are matched to, and in the same or fewer quantities, depending on availability



tempium

good for plants



lIdpe



sottovaso abbinato
fitting saucer



easy for sales



rifinito a mano
hand-finished



impilabile
stackable

180
181

tempium | vaso • pot

art.	size				
*2075	Ø 85 (cm 85 x 66 h)	L 145	1	45	
*2076	Ø 102 (cm 102 x 77 h)	L 250	1	45	
*2077	Ø 114 (cm 114 x 88 h)	L 370	1	45	
*2078	Ø 145 (cm 145 x 114 h)	L 850	1	45	

tempium | sottovaso • saucer



art.	size			
2103	Ø 85 (cm 52 x 5,6 h)	1	45	
2104	Ø 102 (cm 64 x 5,5 h)	1	45	
2105	Ø 114 (cm 70 x 5,5 h)	1	45	
2106	Ø 145 (cm 89 x 6,5 h)	1	45	

* per quantitativi minimi • for minimum orders



i sottovasi possono essere ordinati solo contestualmente ai vasi cui sono abbinati e in quantità uguale, inferiore o secondo la disponibilità • these saucers may only be ordered at the same time as the pots they are matched to, and in the same or fewer quantities, depending on availability



millorighe | cassetta • plant box

art.	size				
1805	cm 60	(cm 58 x 26 x 25 h)	L 29	1	45
1806	cm 70	(cm 68 x 31 x 29 h)	L 45	1	45
1807	cm 80	(cm 77 x 35 x 32 h)	L 70	1	45
1808	cm100	(cm 97 x 44 x 38 h)	L128	1	31 45

millorighe | sottocassetta • oblong tray

art.	size			
1885	cm 60	(cm 63 x 31 x 4 h)	1	45
1886	cm 70	(cm 72 x 36 x 4 h)	1	45
1887	cm 80	(cm 81 x 40 x 4 h)	1	45
1883	cm100	(cm 100 x 47 x 4 h)	1	45



millerighe

good for plants



lIdpe



sottocassetta abbinata
fitting oblong tray



sottovaso abbinato
fitting saucer



easy for sales





rifinito a mano
hand-finished





cassetta vaso abbinati
matching plant box pot

182
183

millerighe | vaso quadro • square pot

art.	size				
1810	cm 30	(cm 31 x 31 x 29 h)	L 18	1	45
1811	cm 35	(cm 35 x 35 x 32 h)	L 28	1	45
1812	cm 45	(cm 44 x 44 x 38 h)	L 51	1	45
2283	cm 55	(cm 55 x 55 x 45 h)	L 99	1	45

neze | sottovaso quadro • square saucer

art.	size			
1629	cm 36	(cm 36 x 36 x 4,5 h)	1	45
1630	cm 42	(cm 42 x 42 x 5,2 h)	1	45
1631	cm 48	(cm 49 x 49 x 5,6 h)	1	45
1632	cm 54	(cm 55 x 55 x 6,0 h)	1	45



tere | cassetta • plant box

art.	size				
1984	cm 100	(cm 97 x 44 x 38 h)	L 128	1	45

tere

good for plants



HDPE



easy for sales



rifinito a mano
hand-finished



cassetta vaso abbinati
matching plant box pot



184
185

tere | vaso quadro • square pot

art.	size				
1985	cm 45	(cm 44 x 44 x 38 h)	L 51	1	45

eden

good for **plants**



100%
Hdpe

easy for **sales**



rifinito a mano
hand-finished



eden | ciotola • plant bowl

art.	size				
1257	Ø 43	(cm 43 x 21 h)	L 11	1	32



giottus

good for plants



lIdpe



sottovaso abbinato
fitting saucer



easy for sales



rifinito a mano
hand-finished



impilabile
stackable

giottus | ciotola • plant bowl

art.	size				
*2139	Ø 30	(cm 30 x 13 h)	L 4	1	45
*2140	Ø 42	(cm 42 x 17 h)	L 11	1	45
*2141	Ø 55	(cm 55 x 22 h)	L 25	1	45
*2284	Ø 70	(cm 73 x 28 h)	L 71	1	45
*2142	Ø 85	(cm 85 x 31 h)	L 86	1	45
*2143	Ø 100	(cm 100 x 36 h)	L 120	1	45
*2066	Ø 130	(cm 130 x 43 h)	L 250	1	45

idria | sottovaso • saucer

art.	size			
2135	Ø 22	(cm 22 x 3,4 h)	1	45
1546	Ø 30	(cm 30 x 5,0 h)	1	45
1548	Ø 36	(cm 36 x 5,0 h)	1	45
1551	Ø 53	(cm 53 x 5,5 h)	1	45
1552	Ø 56	(cm 56 x 6,0 h)	1	45
1553	Ø 63	(cm 63 x 7,0 h)	1	45
*1587	Ø 77	(cm 77 x 7,5 h)	1	45

* per quantitativi minimi • for minimum orders





toscana | cassetta con doppia parete •
plant box with double wall



art.	size				
*1128	cm 100	(cm 95 x 47 x 47 h)	L 84	1	45





toscana | vaso quadro con doppia parete •
square pot with double wall

art.	size				
*1129	cm 50	(cm 47 x 47 x 47 h)	L 35	1	45
*1435	cm 65	(cm 67 x 67 x 62 h)	L 107	1	45

neze | sottovaso quadro • square saucer

art.	size			
1632	cm 54	(cm 55 x 55 x 6,0 h)	1	45
*2094	cm 68	(cm 68 x 68 x 7,3 h)	1	45



balaustra liscia | cassetta • plant box

art.	size				
*2357	cm 50	(cm 50 x 25 x 26 h)	L 25	1	45
*2358	cm 60	(cm 60 x 25 x 26 h)	L 30	1	45
*2359	cm 80	(cm 80 x 25 x 26 h)	L 40	1	45
*2248	cm 100	(cm 100 x 25 x 26 h)	L 50	1	45

kubis | vaso quadro • square pot

art.	size				
*2208	cm 80	(cm 80 x 80 x 65 h)	L 280	1	45

balaustra festonata | sottocassetta • oblong tray

art.	size			
*2379	cm 50	(cm 53 x 27 x 3,7 h)	1	45
*2380	cm 60	(cm 63 x 27 x 3,7 h)	1	45
*1824	cm 80	(cm 80 x 28 x 3,8 h)	1	45
*1825	cm 100	(cm 102 x 28 x 4,0 h)	1	45

ornato

good for plants



lhdpe



sottovaso abbinato
fitting saucer

easy for sales



rifinito a mano
hand-finished



impilabile
stackable

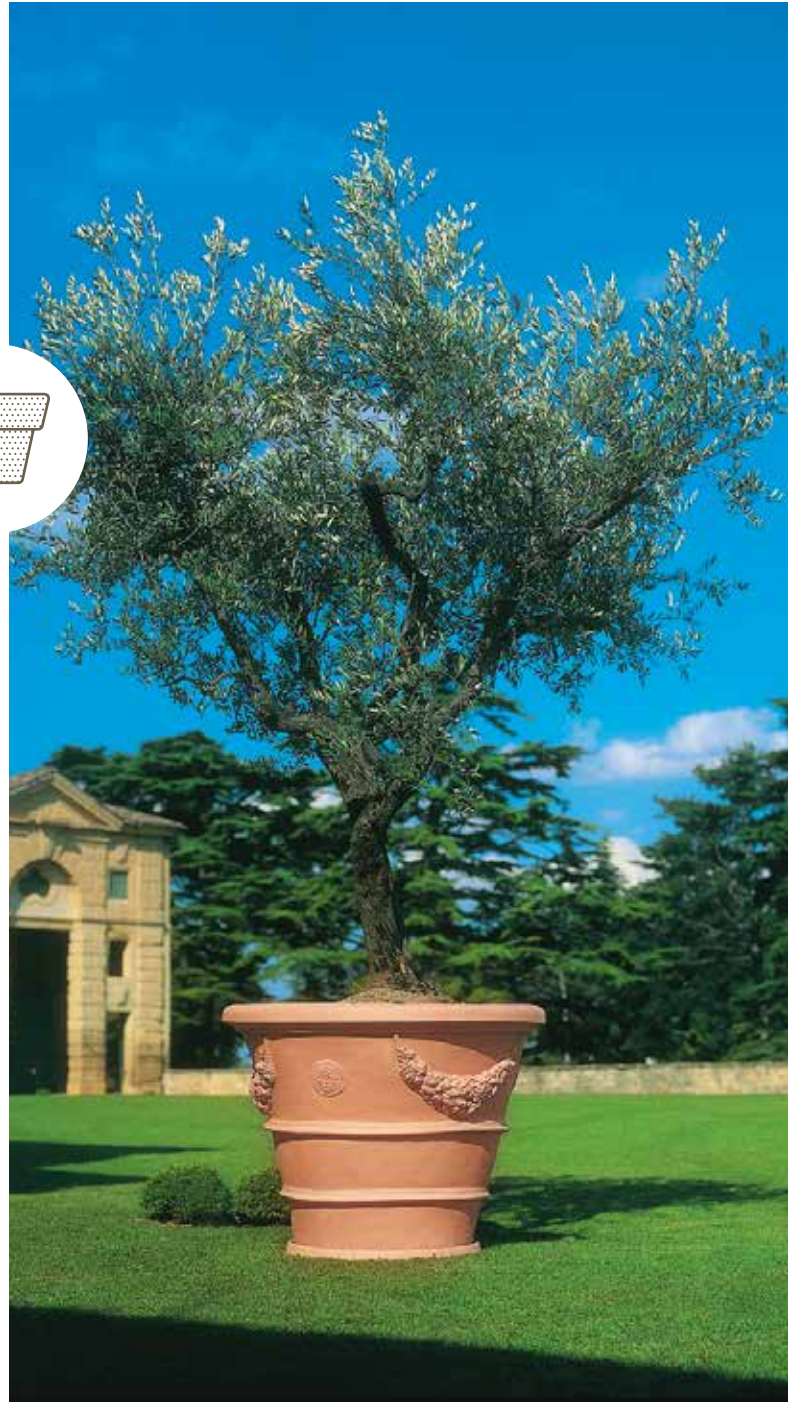

ornato | vaso • pot

art.	size				
*2071	Ø 87	(cm 87 x 67 h)	L 150	1	Ⓢ 45
*2072	Ø 102	(cm 102 x 78 h)	L 270	1	Ⓢ 45
*2073	Ø 114	(cm 114 x 88 h)	L 480	1	Ⓢ 45
*2074	Ø 150	(cm 150 x 115 h)	L 850	1	Ⓢ 45

ornato | sottovaso • saucer

art.	size			
*2099	Ø 87	(cm 55 x 6,0 h)	1	Ⓢ 45
*2100	Ø 102	(cm 68 x 6,5 h)	1	Ⓢ 45
*2101	Ø 114	(cm 75 x 6,0 h)	1	Ⓢ 45
*2102	Ø 150	(cm 90 x 6,7 h)	1	Ⓢ 45

* per quantitativi minimi • for minimum orders

i sottovasi possono essere ordinati solo contestualmente ai vasi cui sono abbinati e in quantità uguale, inferiore o secondo la disponibilità • these saucers may only be ordered at the same time as the pots they are matched to, and in the same or fewer quantities, depending on availability



angeli

good for plants



lIdpe



sottovaso abbinato
fitting saucer



easy for sales



rifinito a mano
hand-finished



impilabile
stackable

angeli | vaso • pot

art.	size				
*1937	Ø 60	(cm 60 x 45 h)	L 50	1	45
*2079	Ø 80	(cm 80 x 60 h)	L 110	1	45
*2080	Ø 103	(cm 103 x 76 h)	L 265	1	45
*2081	Ø 147	(cm 147 x 114 h)	L 930	1	45

angeli | sottovaso • saucer



art.	size			
*2108	Ø 60	(cm 42 x 5,0 h)	1	45
*2096	Ø 80	(cm 48 x 5,0 h)	1	45
*2097	Ø 103	(cm 62 x 5,5 h)	1	45
*2098	Ø 147	(cm 91 x 6,3 h)	1	45

* per quantitativi minimi • for minimum orders



i sottovasi possono essere ordinati solo contestualmente ai vasi cui sono abbinati e in quantità uguale, inferiore o secondo la disponibilità • these saucers may only be ordered at the same time as the pots they are matched to, and in the same or fewer quantities, depending on availability



idria | sottovaso • saucer



art.	size			
2135	Ø 22	(cm 22 x 3,4 h)	1	45
2136	Ø 25	(cm 25 x 3,6 h)	1	45
2137	Ø 28	(cm 28 x 4,0 h)	1	45
1546	Ø 30	(cm 30 x 5,0 h)	1	45
1547	Ø 32	(cm 32 x 5,0 h)	1	45
2138	Ø 33	(cm 33 x 4,2 h)	1	45
1548	Ø 36	(cm 36 x 5,0 h)	1	45
1549	Ø 41	(cm 41 x 5,0 h)	1	45
2293	Ø 44	(cm 44 x 5,2 h)	1	45
1550	Ø 47	(cm 47 x 5,5 h)	1	45
2312	Ø 50	(cm 50 x 5,6 h)	1	45
1551	Ø 53	(cm 53 x 5,5 h)	1	45
1552	Ø 56	(cm 56 x 6,0 h)	1	45
1553	Ø 63	(cm 63 x 7,0 h)	1	45
2313	Ø 70	(cm 70 x 7,1 h)	1	45
*1587	Ø 77	(cm 77 x 7,5 h)	1	45

rondò | sottovaso con ruote montate • saucer with attached wheels



art.	size			
*1570	Ø 30	(cm 30 x 9,5 h)	1	45
*1571	Ø 32	(cm 32 x 9,7 h)	1	45
*1572	Ø 36	(cm 36 x 10,1 h)	1	45
*1573	Ø 41	(cm 41 x 10,7 h)	1	45
*1574	Ø 47	(cm 47 x 11,0 h)	1	45
*1575	Ø 53	(cm 53 x 12,9 h)	1	45
*1576	Ø 56	(cm 56 x 13,3 h)	1	45
*1577	Ø 63	(cm 63 x 13,7 h)	1	45
*1646	Ø 70	(cm 70 x 15,0 h)	1	45
*1589	Ø 77	(cm 78 x 15,5 h)	1	45



neze | sottovaso quadro • square saucer

art.	size			
1628	cm 32	(cm 32 x 32 x 4,5 h)	1	87 45
1629	cm 36	(cm 36 x 36 x 4,5 h)	1	87 45
1630	cm 42	(cm 42 x 42 x 5,2 h)	1	87 45
1631	cm 48	(cm 49 x 49 x 5,6 h)	1	87 45
1632	cm 54	(cm 55 x 55 x 6,0 h)	1	45
2093	cm 61	(cm 61 x 61 x 6,8 h)	1	87 45
*2094	cm 68	(cm 68 x 68 x 7,3 h)	1	45
2095	cm 74	(cm 74 x 74 x 8,0 h)	1	87 45

millerighe | sottocassetta • oblong tray

art.	size			
1885	cm 60	(cm 63 x 31 x 4 h)	1	45
1886	cm 70	(cm 72 x 36 x 4 h)	1	45
1887	cm 80	(cm 81 x 40 x 4 h)	1	C2 G9 87 45
1883	cm 100	(cm 100 x 47 x 4 h)	1	C2 G9 87 45

192
193

* per quantitativi minimi • for minimum orders



putti | fioriera • vase

art.	size			
*1328	Ø 60	(cm 60 x 75 h)	L 60	1 (32)

basamento | basamento • base

art.		
*1252	(cm 41 x 40 x 72 h)	1 (32)





pamir | basamento • base

art.		
*1367	(cm 43 x 43 x 38 h)	1 (32)



impero | fioriera • vase



art.	size				
*1945	Ø 35	(cm 36 x 47 h)	L 5	1	32
*1946	Ø 50	(cm 48 x 60 h)	L 16	1	32
*1237	Ø 65	(cm 65 x 79 h)	L36	1	32

basamento | basamento • base

art.			
*1252	(cm 41 x 40 x 72 h)	1	32



etrusca | fioriera • vase

art.	size				
*1944	Ø 40	(cm 38 x 42 h)	L 7	1	32
*1181	Ø 50	(cm 48 x 54 h)	L 20	1	32
*1213	Ø 65	(cm 61 x 71 h)	L 30	1	32

basamento | basamento • base

art.			
*1252	(cm 41 x 40 x 72 h)	1	32



pashà & oasi

art.			
*1311	poltroncina • small armchair pashà	(cm 78 x 70 x 77 h)	1 
*1312	tavolino • small table oasi	(cm 68 x 50 h)	1 

* per quantitativi minimi • for minimum orders



pashà & oasi

good for plants



100%
lldpe

easy for sales



rifinito a mano
hand-finished



venere milo | statua • statue

art.		
*1416	(cm 42 x 41 x 162 h)	1 (32)

venere | statua • statue

art.		
*1222	(cm 41 x 38 x 165 h)	1 (32)

pamir grande | basamento • base

art.		
*1437	(cm 43 x 43 x 38 h)	1 (32)

pedistallo per statua | pedestal for statue

art.		
*1223	(cm 48 x 38 h)	1 (32)

venere milo piccola | statua • statue

art.		
*1417	(cm 32 x 33 x 115 h)	1 (32)

venere piccola | statua • statue

art.		
*1418	(cm 33 x 31 x 115 h)	1 (32)

pamir | basamento • base

art.		
*1367	(cm 43 x 43 x 38 h)	1 (32)

pamir | basamento • base

art.		
*1367	(cm 43 x 43 x 38 h)	1 (32)

venere milo mini | statua • statue

art.		
*1740	(cm 21 x 20 x 85 h)	1 (32)

venere mini | statua • statue

art.		
*1739	(cm 23 x 22 x 85 h)	1 (32)

thera | basamento • base

art.		
*1536	(cm 35 x 35 x 40 h)	1 (32)

thera | basamento • base

art.		
*1536	(cm 35 x 35 x 40 h)	1 (32)

* per quantitativi minimi • for minimum orders



putto toscano | statua • statue

art.			
*1542	(cm 32 x 25 x 82 h)	1	32

thera | basamento • base

art.			
*1536	(cm 35 x 35 x 40 h)	1	32

leone | statua • statue



art.			
*1561	(cm 41 x 21 x 52 h)	1	32
*1251	(cm 52 x 26 x 63 h)	1	32
*1426	(cm 48 x 29 x 77 h)	1	32

basamento | basamento • base

art.			
*1252	(cm 41 x 40 x 72 h)	1	32



quattro stagioni | statua • statue



art.				
*1540	primavera	(cm 41 x 33 x 119 h)	1	32
*1538	estate	(cm 37 x 34 x 121 h)	1	32

quattro stagioni | basamento • base

art.			
*1541	(cm 45 x 19 h)	1	32



quattro stagioni | statua • statue

art.				
*1537	autunno	(cm 38 x 32 x 122 h)	1	32
*1539	inverno	(cm 39 x 34 x 122 h)	1	32

quattro stagioni | basamento • base

art.			
*1541	(cm 45 x 19 h)	1	32



donna francese | busto • bust

art.			
*1602	(cm 37 x 22 x 50 h)	1	32

lindos | colonna • column

art.	size.			
*1604	h 40	(cm 36 x 40 h)	1	32



venere | busto • bust

art.		
*1355	(cm 34 x 25 x 57 h)	1 (32)

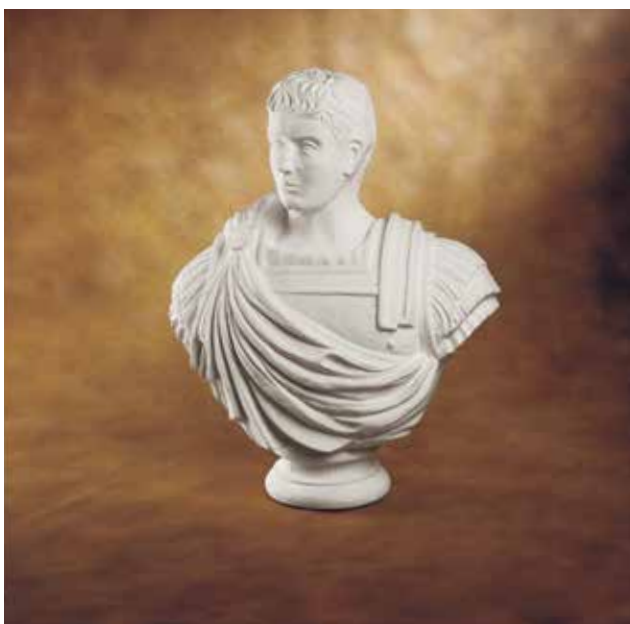

cesare augusto | busto • bust

art.		
*1330	(cm 60 x 30 x 72 h)	1 (32)



pompei | capitello quadro • square capital

art.		
*1460	(cm 50 x 50 x 71 h)	1 (32)



rodi | colonna • column

art.	size.		
*1659	h 236	(cm 45 x 45 x 236 h)	1 (32)

rodi | capitello • capital

art.		
*1660	(cm 45 x 45 x 34 h)	1 (32)



pompei | colonna • column

art.	size.		
*1297	h 210	(cm 43 x 43 x 210 h)	1 (32)

creta | colonna • column

art.	size.		
*1298	h 110	(cm 44 x 44 x 105 h)	1 (32)





kos | colonna • column

art.	size.		
*1603	h 70	(cm 38 x 38 x 70 h)	1 (32)



lindos | colonna • column

art.	size.		
*1604	h 40	(cm 36 x 40 h)	1 (32)
*1605	h 69	(cm 36 x 69 h)	1 (32)



zetis | colonna • column

art.	size.		
*2120	h 92	(cm 40 x 92 h)	1 (32)



panchina semitonda | panchina semitonda •
half-round bench

art.		
*1305	(cm 135 x 45 x 45 h)	1 (32)



paracarro con catena | paracarro con catena •
post with chain

art.		
*1260	(cm 35 x 35 x 74 h)	1 (32)



pilastro per balaustra | pilastro per balaustra •
balustrade pilaster

art.		
*1304	(cm 41 x 41 x 87 h)	1 (32)



balaustra | balaustra • balustrade

art.			
*1302	(cm 116 x 35 x 87 h)	1	32



balaustra per fiori | balaustra per fiori •
balustrade for flowers

art.			
*1303	(cm 116 x 35 x 87 h)	1	32



conchiglia | fontana • fountain

art.		
*1422	(cm 67 x 45 x 121 h)	1 (32)

fontana con attacco acqua • fountain w/water connection

*1428	(cm 67 x 45 x 121 h)	1 (32)
-------	----------------------	--------



nettuno | fontana • fountain

art.		
*1369	(cm 59 x 54 x 123 h)	1 (08)



pamir | basamento • base

art.		
*1367	(cm 43 x 43 x 38 h)	1 (32)



basamento | basamento • base

art.		
*1252	(cm 41 x 40 x 72 h)	1 32



truk | carrello con timone •
wagon with handle

art.		
*2149	(cm 110 x 57 x 42 h)	1 09
port. max. 60 Kg		

Avvertenze

Warnings

1. Tutti i prodotti sono utilizzabili sia negli spazi interni che esterni.

The entire range of products can be used indoors or outdoors.

2. Non posizionare l'articolo su una superficie irregolare o inclinata, per evitare movimenti incontrollati.

Do not position the product on an uneven or sloping surface; this will avoid uncontrolled movements.

3. Tenere l'articolo lontano da fonti di calore.

Keep the article away from heat sources.

4. Gli articoli con pareti dritte realizzati con la tecnica "rotazionale" possono presentare delle non planarità (warpage) che potrebbero accentuarsi qualora il prodotto venisse esposto alla luce diretta del sole.

Products with straight walls made using the rotational moulding system may show some warping that could become more obvious if the pot is exposed to direct sunlight.

5. Pulire gli articoli con una spugna bagnata con acqua e detergente liquido neutro. Risciacquare con un panno bagnato. Si raccomanda di evitare l'uso di panni abrasivi e di detersivi contenenti solventi e/o alcool etilico. In caso di sporco ostinato richiedere il detergente Euro3plast.

Clean the articles with a damp cloth and neutral liquid detergent. Rinse with a clean damp cloth Do not use abrasive cloths or cleaning agents containing solvents and/or ethyl alcohol. For stubborn stains use the special Euro3plast detergent.

LIGHTS

1. Tutte le lampade presenti in questo catalogo dispongono di un kit luce già installato.

All the lamps included in this catalogue are supplied with a light kit already installed.

2. In caso di sostituzione della lampadina, assicurarsi che la presa di corrente sia scollegata.

Before replacing a bulb make sure that the power plug has been disconnected.

3. Collegare la spina dell'apparecchio in una presa collocata in un luogo protetto dalla pioggia e dagli spruzzi d'acqua.

Connect the plug of the appliance to a power outlet that is located in a sheltered position, protected from rain and water splashes.

4. L'articolo "Sfera a sospensione" che monta il kit a sospensione (A4596), se utilizzato all'esterno, dovrà essere posizionato in luogo coperto.

If used outdoors, the article "Suspended light sphere" that mounts the suspension kit (A4596) must be installed in a covered context.

5. Se il cavo flessibile esterno di questo apparecchio viene danneggiato, deve essere sostituito esclusivamente dal costruttore, dal suo servizio di assistenza, o da personale qualificato equivalente, al fine di evitare pericoli.

If the external flexible cable of this appliance is damaged it must be replaced by either the manufacturer, the manufacturer's customer assistance service or by equivalent qualified personnel, in order to prevent possible hazards.

6. Nelle versioni sprovviste di interruttore sul cavo di alimentazione, collegare la spina dell'apparecchio sotto una presa comandata da interruttore.

For models that are not equipped with an inline on/off switch, connect the plug of the appliance to a switch controlled outlet.

7. Si sconsiglia l'utilizzo e/o l'installazione dei prodotti luminosi su superfici/pavimentazioni non solide (sabbia, terra, erba, sassi, ghiaia, ecc.). Inoltre, i prodotti luminosi non dovranno essere installati in prossimità (adiacenti e sullo stesso piano) di piscine e/o ambienti d'acqua.

The use and/or installation of illumination devices on instable surfaces/floors or pavement (sand, soil, grass, stones, gravel, etc.) is discouraged. Neither must illumination devices be installed near (adjacent to or on the same level as) swimming pools and/or other water environments.

8. Gli oggetti luminosi, se allestiti con terra, piante e/o vasi, dovranno essere fissati al suolo con i nostri sistemi di ancoraggio, ove previsti.

If light articles are set up with soil, plants and/or vases, they must be secured to the ground with our anchoring systems, where provided.

9. I vasi light outdoor sono dotati di fori di drenaggio all'interno e sul fondo del vaso, oppure di canaletta di scolo. Entrambe le soluzioni servono per favorire la fuoriuscita dell'acqua in eccesso.

The light outdoor pots have drainage holes inside and on the base, or a drainage tube. Both solutions are to allow excess water to drain away.

10. Euro3Plast S.p.A. declina ogni responsabilità per danni causati a cose o a persone da un uso improprio del prodotto.

Euro3Plast S.p.A. cannot accept liability for any damage caused to things or persons by an incorrect use of the product.

Kit luce

Light kit

kit luce in PC per **interni**
indoor PC light kit

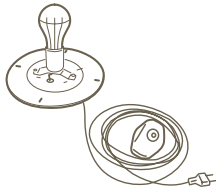

Il kit luce è venduto con una lampada di classe energetica E.

The light kit is sold with a bulb of the energy class E.

art. A4279

dettagli • details

piastra in policarbonato • polycarbonate plate
cavo trasparente • transparent cable
pulsantiera a pedale • foot switch
spina europea bipolare • european bipolar plug
lunghezza cavo • wire length: **cm 370**

luce • light
1 x 8,5 W



kit luce in PC per **esterni**
outdoor PC light kit

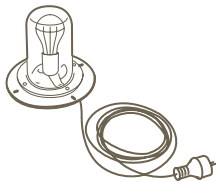

Il kit luce è venduto con una lampada di classe energetica E.

The light kit is sold with a bulb of the energy class E.

art. A4280

dettagli • details

piastra in policarbonato • polycarbonate plate
guscio in policarbonato • polycarbonate shell
guarnizione a tenuta • gasket seal
cavo nero • black cable
spina schuko antispruzzo • anti-splash
lunghezza cavo • wire length: **cm 280**

luce • light
1 x 8,5 W



kit luce in PC RGB E27 per **interni**
indoor PC RGB E27 light kit



Il kit luce è venduto con una lampada di classe energetica F.

The light kit is sold with a bulb of the energy class F.

art. A4719

dettagli • details

piastra in policarbonato • polycarbonate plate
cavo trasparente • transparent cable
pulsantiera a pedale • foot switch
spina europea bipolare • european bipolar plug
lunghezza cavo • wire length: **cm 370**

luce • light
1 x 8 W - 50/60 Hz



kit luce in PC RGB E27 per **esterni** outdoor PC RGB E27 light kit



Il kit luce è venduto con una lampada di classe energetica F.

The light kit is sold with a bulb of the energy class F.

art. A4720

dettagli • details

piastra in policarbonato • polycarbonate plate
guscio in policarbonato • polycarbonate shell
guarnizione a tenuta • gasket seal
cavo nero • black cable
spina schuko antispruzzo • anti-splash
lunghezza cavo • wire length: **cm 280**

luce • light
1 x 8 W - 50/60 Hz



kit luce in PC RGB E27 con telecomando per **interni** indoor PC RGB E27 light kit with remote control



Il kit luce è venduto con una lampada di classe energetica F.

The light kit is sold with a bulb of the energy class F.

art. A4710

dettagli • details

piastra in policarbonato • polycarbonate plate
telecomando • remote control
cavo trasparente • transparent cable
pulsantiera a pedale • foot switch
spina europea bipolare • european bipolar plug
lunghezza cavo • wire length: **cm 370**

luce • light
1 x 8 W - 50/60 Hz



kit luce in PC RGB E27 con telecomando per **esterni** outdoor PC RGB E27 light kit with remote control



Il kit luce è venduto con una lampada di classe energetica F.

The light kit is sold with a bulb of the energy class F.

art. A4711

dettagli • details

piastra in policarbonato • polycarbonate plate
guscio in policarbonato • polycarbonate shell
telecomando • remote control
guarnizione a tenuta • gasket seal
cavo nero • black cable
spina schuko antispruzzo • anti-splash
lunghezza cavo • wire length: **cm 280**

luce • light
1 x 8 W - 50/60 Hz



Kit LED RGB a batteria per **interni/esterni** bluetooth
Bluetooth RGB LED light kit with battery **indoor/outdoor**



art. A4744

dettagli • details

kit led rgb powered by smart&green
autonomia 8 ore circa alla massima intensità
autonomy 8 hours on average at maximum power
base di ricarica con spina europea bipolare
european bipolar plug charger
batteria li-ion polimeri 3,7V 2200 mAh
battery li-ion 3,7V 2200 mAh
Trasmissione senza filo: bluetooth 4.0
Wireless transmission: bluetooth 4.0

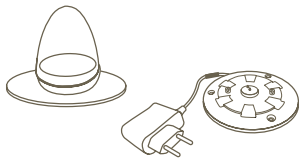

luce • light

35 led: 20 led bianchi e 15 led colorati - 1,2 W
35 leds: 20 white leds and 15 color leds - 1,2 W



IP 68



kit mini led light per **interni**
mini led light kit **indoor**

art. A4303

dettagli • details

cavo trasparente • transparent cable
spina europea bipolare • european bipolar plug
trasformatore in 12V a parete • 12V wall transformer
pulsantiera • switch
lunghezza cavo • wire length: cm 140

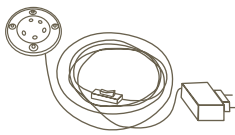

Il kit luce è munito di una sorgente luminosa a LED con classe energetica E.

The light kit is equipped with a LED light source with energy class E.

luce • light

modulo 6 led bianchi 1,5 W
1,5 W white 6 led module



IP 20



kit luce a sospensione per **interni/esterni**
indoor/outdoor light kit to suspension

art. A4596

dettagli • details

piastra in policarbonato • polycarbonate plate
guscio in policarbonato • polycarbonate shell
guarnizione a tenuta • gasket seal
cavo nero • black cable
lunghezza cavo • wire length: cm 200
fili in acciaio per la sospensine • steel wires for suspension
staffa metallica di fissaggio a soffitto • metal bracket for ceiling mount
rosone metallico • metal ceiling rose
kit luce regolabile in altezza • light kit adjustable in height

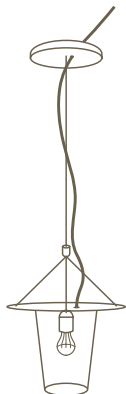

luce • light

1 x 8,5 W



CL. I



IP 44



Il kit luce è venduto con una lampada di classe energetica E.

The light kit is sold with a bulb of the energy class E.

Legenda/Legend



Lampadina a LED MAX 1 x 11,5 W
LED bulb MAX 1 x 11,5 W



Classe di isolamento: Classe I.
Apparecchio protetto alla scossa elettrica tramite isolamento principale e provvisto di un dispositivo per la messa a terra.
Protection class: Class I
Apparatus protected against electric shock through main insulation, and provided with grounding device.



Classe di isolamento: Classe II.
Con doppio isolamento e/o rinforzo in ogni parte e senza dispositivi per la messa a terra.
Insulation class: Class II.
With double insulation and/or reinforcement in each part and without ground devices.



Classe di isolamento: Classe III
Con isolamento ridotto perchè destinato a essere esclusivamente alimentato da un sistema a bassissima tensione di sicurezza (minore o uguale a 48V dc) e nel quale si generano tensioni di valore superiore a quello di tale sistema.
Insulation class: Class III.
With reduced insulation because the device is destined to be powered exclusively by a safety extra-low voltage system (max. 48V DC or less) in which voltages of values higher than those of such system are generated.



Attesta la conformità del prodotto alle disposizioni delle direttive comunitarie.
It certifies the conformity of the product to the European community instructions.

IP 20

Prodotto di uso ordinario. Protetto contro corpi solidi di diametro superiore a 12,5mm. L'utente non ha comunque modo di entrare in contatto con le parti in tensione. Prodotto con nessuna protezione nei confronti della penetrazione dell'acqua.
Product for ordinary use, protected against solid objects larger than 12.5 mm in diameter. Users cannot however come into contact with the live parts. This product has no water protection.

IP 44

Protetto contro corpi solidi di diametro superiore ad 1 mm. Prodotto resistente agli spruzzi d'acqua.
Protected against solid bodies with a diameter over 1 mm. Splash-resistant product.

IP 67

Totamente protetto contro la penetrazione di polveri. Prodotto resistente all'immersione temporanea massimo ad 1m di profondità. L'icona, dove presente, fa riferimento al corpo lampada.
Totally protected against penetration of dust. Product resistant against temporary immersion in water to a maximum of 1 m depth. Wherever present, the icon refers to the lamp's casing.

IP 68

Totamente protetto contro la penetrazione di polveri. Prodotto resistente alla sommersione permanente in acqua. L'icona, dove presente, fa riferimento al corpo lampada.
Totally protected against penetration of dust. Product resistant against permanent immersion in water. Wherever present, the icon refers to the lamp's casing.



Ai sensi della Direttiva 2012/19/UE, il prodotto, alla fine della sua vita utile, non deve essere smaltito come rifiuto urbano.
According to the Directive 2012/19/UE, once the device life time is ended, it must not be disposed as urban waste.

Tutte le apparecchiature elettriche sono conformi alle direttive 2011/65/UE sulle Restrizioni d'uso di alcune sostanze pericolose (RoHS), recepite in Italia con il D.lgs 04/03/2014 n.27.

All electric equipments meet the Directives 2011/65/UE about the Reduction of the use of certain Hazardous Substances (RoHS), which came into force in Italy with D. lgs 04/03/2014 n.27.

Avvertenze - Warning:

- Tutte le lampade presenti in questo catalogo dispongono di un kit luce già installato.
- In caso di sostituzione della lampadina, assicurarsi che la presa di corrente sia scollegata.
- Collegare la spina dell'apparecchio in una presa collocata in un luogo protetto dalla pioggia e dagli spruzzi d'acqua.
- L'articolo "Sfera a sospensione" che monta il kit a sospensione (A4596), se utilizzato all'esterno, dovrà essere posizionato in luogo coperto.
- Se il cavo flessibile esterno di questo apparecchio viene danneggiato, deve essere sostituito esclusivamente dal costruttore, dal suo servizio di assistenza, o da personale qualificato equivalente, al fine di evitare pericoli.
- Nelle versioni sprovviste di interruttore sul cavo di alimentazione, collegare la spina dell'apparecchio sotto una presa comandata da interruttore.
- Si sconsiglia l'utilizzo e/o l'installazione dei prodotti luminosi su superfici/pavimentazioni non solide (sabbia, terra, erba, sassi, ghiaia, ecc.). Inoltre, i prodotti luminosi non dovranno essere installati in prossimità (adiacenti e sullo stesso piano) di piscine e/o ambienti d'acqua.
- Gli oggetti luminosi, se allestiti con terra, piante e/o vasi, dovranno essere fissati al suolo con i nostri sistemi di ancoraggio, ove previsti.
- I vasi light outdoor sono dotati di fori di drenaggio all'interno e sul fondo del vaso, oppure di canaletta di scolo. Entrambe le soluzioni servono per favorire la fuoriuscita dell'acqua in eccesso.
- Euro3Plast S.p.A. declina ogni responsabilità per danni causati a cose o a persone da un uso improprio del prodotto.
- All the lamps included in this catalogue are supplied with a light kit already installed.
- Before replacing a bulb make sure that the power plug has been disconnected.
- Connect the plug of the appliance to a power outlet that is located in a sheltered position, protected from rain and water splashes.
- If used outdoors, the article "Suspended light sphere" that mounts the suspension kit (A4596) must be installed in a covered context.
- If the external flexible cable of this appliance is damaged it must be replaced by either the manufacturer, the manufacturer's customer assistance service or by equivalent qualified personnel, in order to prevent possible hazards.
- For models that are not equipped with an inline on/off switch, connect the plug of the appliance to a switch controlled outlet.
- The use and/or installation of illumination devices on instable surfaces/floors or pavement (sand, soil, grass, stones, gravel, etc.) is discouraged. Neither must illumination devices be installed near (adjacent to or on the same level as) swimming pools and/or other water environments.
- If light articles are set up with earth, plants and/or vases, they must be secured to the ground with our anchoring systems, where provided.
- The light outdoor pots have drainage holes inside and on the base, or a drainage tube. Both solutions are to allow excess water to drain away.
- Euro3Plast S.p.A. cannot accept liability for any damage caused to things or persons by an incorrect use of the product.

indice generale general index

art.	pag.
a:	
air (s/vaso trasparente • transparent saucer)	p. 67
akan (cassetta • plant box)	p. 162
akan (vaso quadro • square pot)	p. 163
akea (cassetta • plant box)	p. 40
akea (s/cassetta • oblong tray)	p. 41
angeli (s/vaso • saucer)	p. 191
angeli (vaso • pot)	p. 191
b:	
balaustra (balustrade)	p. 205
balaustra per fiori (balustrade for flowers)	p. 205
balaustra festonata (s/cassetta • oblong tray)	p. 189
balaustra liscia (cassetta • plant box)	p. 189
basamento (base)	p. 207
be up (cassetta • plant box)	p. 84
be up (vaso • pot)	p. 82
c:	
cesare augusto (busto • bust)	p. 201
cilindro (s/vaso • saucer)	p. 180
cilindro (vaso • pot)	p. 30
cilindro rot (vaso • pot)	p. 180
clivo satin (cassetta • plant box)	p. 100
clivo orchidea satin (vaso senza fori • pot without holes)	p. 98
clivo satin (vaso con fori • pot with holes)	p. 96
coccio (vaso • pot)	p. 32
conchiglia (fontana • fountain)	p. 206
creta (colonna • column)	p. 202
d:	
domus (gerla con s/vaso • wall pot with saucer)	p. 51
donna francese (busto • bust)	p. 200
doppio bordo (s/vaso • saucer)	p. 177
doppio bordo (vaso • pot)	p. 177
dune (vaso • pot)	p. 34
e:	
eden (ciotola • plant bowl)	p. 186
etria (vaso con doppia parete • pot with double wall)	p. 142
etria uno (vaso con singola parete • pot with single wall)	p. 143
etrusca (fioriera • vase)	p. 195
eur (s/vaso • saucer)	p. 178

art. pag.

f:

festonato (vaso • pot) p. 178
festum (vaso • pot) p. 179

g:

garden (s/cassetta • oblong tray) p. 50
garden (vaso • pot) p. 38
gardenie (cassetta • plant box) p. 48
gardenie (s/cassetta • oblong tray) p. 49
geo (vaso • pot) p. 28
gerani (cassetta • plant box) p. 50
gerani (s/cassetta • oblong tray) p. 50
giottus (ciotola • plant bowl) p. 187

i:

idria (s/vaso • saucer) p. 192
ikon (s/vaso • saucer) p. 139
ikon (vaso • pot) p. 138
ikon (vaso con fori • pot with holes) p. 140
ikon (vaso con fori chiuso sopra • pot with holes closed on top) p. 141
ilie (vaso • pot) p. 144
ilie gloss (vaso • pot) p. 146
ilie (vaso light • light pot) p. 148
impero (fioriera • vase) p. 195
inis (cassetta • plant box) p. 46
inis (s/cassetta • oblong tray) p. 47

k:

kalis (cassetta • plant box) p. 52
kalis (s/cassetta • oblong tray) p. 53
kiam (vaso quadro • square pot) p. 150
kiam gloss (vaso quadro • square pot) p. 152
kiam (vaso quadro light • square light pot) p. 154
kos (colonna • column) p. 203
krea (s/vaso a muro • wall saucer) p. 45
krea (s/vaso angolo • angle saucer) p. 44
krea (s/vaso quadro • square saucer) p. 43
krea (vaso a muro • wall pot) p. 45
krea (vaso angolo • angle pot) p. 44
krea (vaso quadro • square pot) p. 42
kube (cassetta • plant box) p. 112
kube (cassetta con ruote • plant box with castors) p. 112
kube (panca • bench) p. 132
kube (panca light • light bench) p. 134
kube (sgabello • stool) p. 133
kube (sgabello light • light stool) p. 135
kube (vaso • pot) p. 113
kube (vaso con ruote • pot with castors) p. 113

indice generale general index

art.	pag.
k:	
kube gloss (vaso • pot)	p. 114
kube high (cassetta alta • high plant box)	p. 120
kube high (cassetta alta con ruote • high plant box with castors)	p. 120
kube high (cassetta alta light • high light plant box)	p. 122
kube high (vaso alto • high pot)	p. 121
kube high (vaso alto con ruote • high pot with castors)	p. 121
kube high (vaso alto light • high light pot)	p. 123
kube high slim (cassetta alta • high plant box)	p. 124
kube high slim (cassetta alta light • high light plant box)	p. 126
kube high slim (vaso alto • high pot)	p. 125
kube high slim (vaso alto light • high light pot)	p. 127
kube mini (cassetta • plant box)	p. 116
kube mini (cassetta light • light plant box)	p. 118
kube mini (cubo light • light cube)	p. 136
kube mini (vaso • pot)	p. 117
kube mini (vaso light • light pot)	p. 119
kube tower (cassetta alta • high plant box)	p. 128
kube tower (cassetta alta light • high light plant box)	p. 130
kube tower (vaso alto • high pot)	p. 129
kube tower (vaso alto light • high light pot)	p. 131
kubis (vaso quadro • square pot)	p. 189
kuno gloss (vaso • pot)	p. 156
l:	
leone (statua • statue)	p. 199
libis (ciotola con s/vaso montato • plant bowl with attached saucer)	p. 60
licum (cassetta con s/cass. mont. • plant box with oblong tray)	p. 54
liken (vaso • pot)	p. 102
lindos (colonna • column)	p. 203
linto (vaso • pot)	p. 36
m:	
medea (s/vaso • saucer)	p. 62
millerighe (cassetta • plant box)	p. 182
millerighe (s/cassetta • oblong tray)	p. 193
millerighe (vaso quadro • square pot)	p. 183
mini (s/cassetta • oblong tray)	p. 68
mitu pac cm 100 (cassetta con fori • plant box with holes)	p. 86
mitu pac (cassetta con fori • plant box with holes)	p. 90
mitu pac (vaso con fori • pot with holes)	p. 92
mitu pac quadro (vaso con fori quadro • square pot with holes)	p. 88
miu (vaso • pot)	p. 104
miza (cassetta • plant box)	p. 56
miza (s/cassetta • oblong tray)	p. 57
moplen (s/cassetta • oblong tray)	p. 68
moplen (s/vaso • saucer)	p. 66

art.	pag.
N:	
nettuno (fontana • fountain)	p. 206
neze (s/vaso quadro • square saucer)	p. 193
O:	
oasi & pashà (tavolino & poltroncina • small table & small armchair)	p. 196
olimpo (ciotola • plant bowl)	p. 58
ornato (s/vaso • saucer)	p. 190
ornato (vaso • pot)	p. 190
P:	
pamir (basamento • base)	p. 206
pamir grande (basamento • base)	p. 198
panchina semitonda (halfround bench)	p. 204
paracarro con catena (post with chain)	p. 204
pashà & oasi (poltroncina & tavolino • small armchair & small table)	p. 196
pedino (pedino • little base)	p. 51
pedistallo per statua (pedestal for statue)	p. 198
pilastro per balaustra (balustrade pilaster)	p. 204
pompei (capitello quadro • square capital)	p. 202
pompei (colonna • column)	p. 202
putti (fioriera • vase)	p. 194
putto toscano (statua • statue)	p. 199
Q:	
quadria (vaso • pot)	p. 108
quadrum (vaso quadro • square pot)	p. 158
quattro stagioni (basamento • base)	p. 200
quattro stagioni (statua autunno • autumn statue)	p. 200
quattro stagioni (statua estate • summer statue)	p. 200
quattro stagioni (statua inverno • winter statue)	p. 200
quattro stagioni (statua primavera • spring statue)	p. 200
R:	
rodi (capitello • capital)	p. 202
rodi (colonna • column)	p. 202
rondò (s/vaso con ruote montate • saucer with attached wheels)	p. 192
S:	
sabbiato (s/vaso • saucer)	p. 66
satin (s/vaso • saucer)	p. 96
sfera (light sphere)	p. 164
sfera a sospensione (suspended light sphere)	p. 165
sfera con piedistallo (light sphere with pedestal)	p. 166
sfera mini (mini light sphere)	p. 168
siepi (cassetta • plant box)	p. 170
siepi (cassetta con doppia parete • plant box with double wall)	p. 172
siepi (s/cassetta • oblong tray)	p. 172
siepi (vaso • pot)	p. 174

indice generale general index

art.	pag.
S:	
siepi (vaso a muro • wall pot)	p. 175
siepi (vaso quadro • square pot)	p. 171
siepi (vaso quadro con doppia parete • square pot with double wall)	p. 173
sottovaso a muro (wall saucer)	p. 175
synue (vaso • pot)	p. 106
s/vaso con ruote (s/vaso con ruote montate • saucer with attached wheels)	p. 64
t:	
tempium (s/vaso • saucer)	p. 181
tempium (vaso • pot)	p. 181
tere (cassetta • plant box)	p. 184
tere (vaso quadro • square pot)	p. 185
thera (basamento • base)	p. 199
toscana (cassetta con doppia parete • plant box with double wall)	p. 188
toscana (vaso quadro con doppia parete • square pot with double wall)	p. 188
truk (carrello con timone • wagon with handle)	p. 207
tuit (vaso con container • pot with container)	p. 72
tuit krome (vaso con container • pot with container)	p. 76
tuit laccato opaco (vaso laccato opaco con container • matt lacquered pot with container)	p. 74
tulum (vaso • pot)	p. 160
U:	
ulivum (conca • conch)	p. 176
ulivum (s/vaso conca • conch saucer)	p. 176
up (cassetta • plant box)	p. 80
up (vaso • pot)	p. 78
V:	
venere (busto • bust)	p. 201
venere (statua • statue)	p. 198
venere mini (statua • statue)	p. 198
venere piccola (statua • small statue)	p. 198
venere milo (statua • statue)	p. 198
venere milo mini (statua • statue)	p. 198
venere milo piccola (statua • small statue)	p. 198
Z:	
zetis (colonna • column)	p. 203

—

ATTENZIONE: La stampa su carta non sempre riproduce fedelmente i colori dei prodotti.

Le immagini e i dati riportati in questo catalogo sono indicativi. **Euro3plast spa** si riserva il diritto di apportare eventuali variazioni o migliorie agli articoli illustrati, anche senza preavviso. I nostri uffici commerciali rimangono a vostra completa disposizione per qualsiasi ulteriore delucidazione.

Tutto il materiale contenuto in questo catalogo, compresi i testi, le fotografie, i disegni, è proprietà di **euro3plast spa** e pertanto è protetto dalle leggi che tutelano la proprietà intellettuale. Per tale motivo non può essere utilizzato senza esplicita autorizzazione scritta da **euro3plast spa**.

ATTENTION: The print on the paper doesn't grant the accurate reproduction of the colors.

The images and the indicated data in our catalogue are approximate. **Euro3plast spa** reserves the right to effect any changes or improvements, to the illustrated articles, also without notice. For further information, our Customer Service are at your disposal.

All the material in this catalogue (including texts, photos and drawing), belong to **euro3plast spa**. Therefore it is protected by laws defending intellectual property. For this reason it cannot be used by anybody without the prior and written authorization of **euro3plast spa**.



8 000072 142136

printed in italy 10/2023

Ihr Ansprechpartner in Österreich

T O R I A
KUNSTSTOFFHANDELS GMBH

Madstein 19 | 8772 Traboch | AUSTRIA
T +43 3847 8115 | F +43 3847 8115-30
verkauf@toria.at | www.toria.at